

# Canon

## SPEEDLITE 540EZ

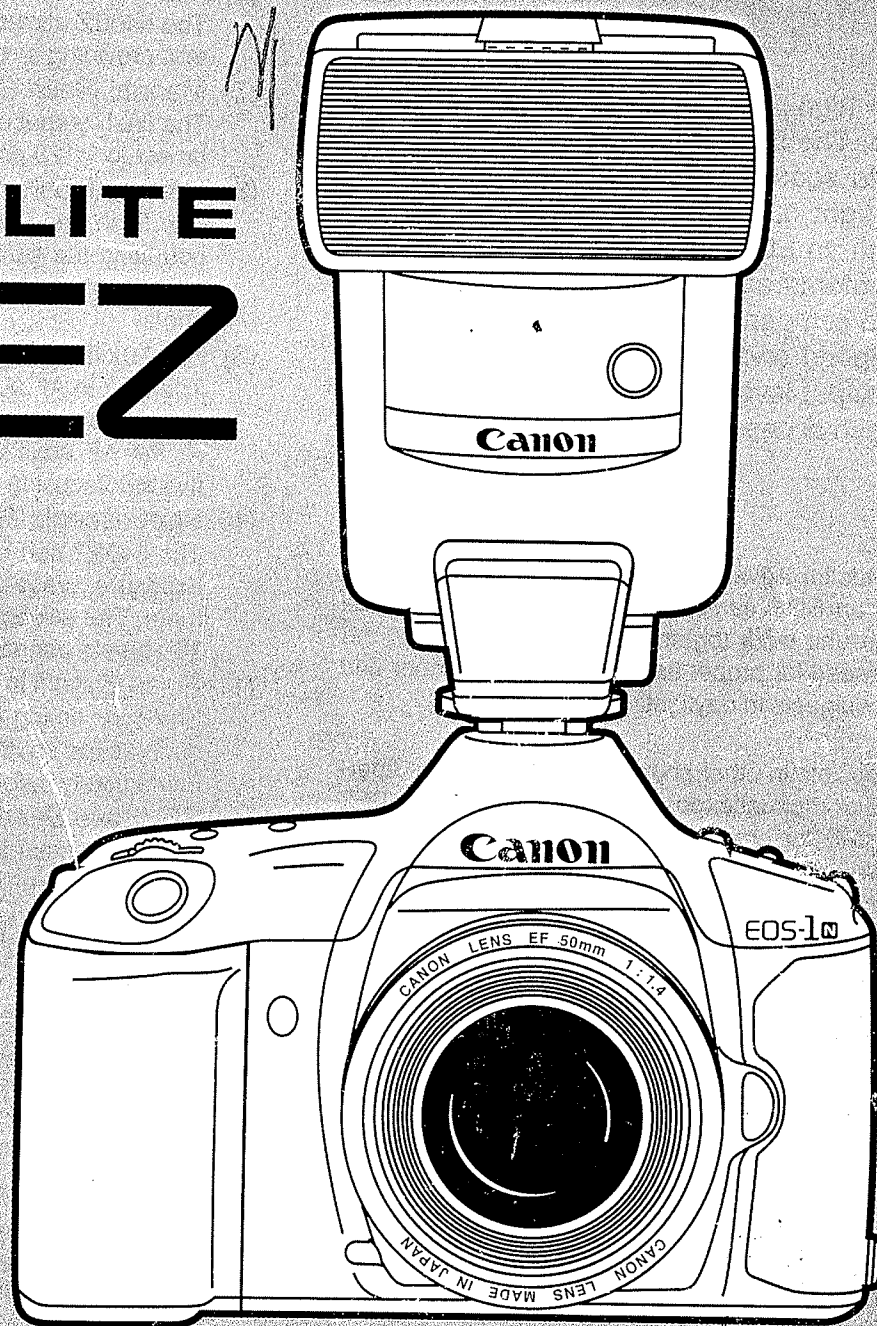

Instruction Book



English  
Edition

## Thank you for purchasing this Canon product.

The Canon Speedlite 540EZ is a high-performance flash unit designed for use with EOS Series cameras. The 540EZ incorporates a rich selection of features, including an auto zoom function, TTL automatic flash exposure control, and powerful light output sufficient for virtually any shooting situation. When used with an EOS camera, the 540EZ is capable of everything from simple, automated flash shooting to advanced techniques such as flash exposure compensation, automatic flash control based on user-selected shutter speed and/or aperture settings, manual firing with eight selectable flash output levels, and intricate multiple-flash lighting setups using EOS multi-flash accessories.

### ● 540EZ Features

- (1) **A-TTL Automatic Flash Control**  
A-TTL automatic flash control stands for Advanced Through The Lens automatic flash control. When used with an EOS camera set to Program AE or Full Auto mode, the camera and flash unit work together to automatically set the appropriate aperture and shutter speed for proper flash exposure for indoor and low-light scenes as well as backlit subjects in daylight.
  - (2) **TTL Automatic Flash Control**  
TTL automatic flash shooting is possible in other shooting modes such as aperture-priority AE, shutter-priority AE or manual exposure mode. When the 540EZ is combined with aperture-priority AE for an indoor shot or a night scene, the camera automatically sets a slow shutter speed to properly expose the background while the flash fires to properly expose the subject.
  - (3) **Three-Zone Flash Metering for Multi-Point Autofocus Systems**  
When the 540EZ is used with an EOS camera that has multiple focusing points, the flash automatically weights the exposure in the area of the active focusing point using the camera's three-zone flash metering system.
  - (4) **Automatic Flash Exposure Confirmation**  
After a picture is taken using flash, an LED on the back of the flash unit lights for two seconds to indicate that proper flash exposure was achieved.
  - (5) **Auto Zoom**  
The flash head automatically zooms to set the proper flash coverage angle according to the lens focal length. Settings from 24mm wide-angle to 105mm telephoto are possible with the flash alone, and coverage for ultra-wide-angle lenses down to 18mm is possible using the built-in wide panel. The flash coverage angle can also be set manually to any desired position.
  - (6) **Flash Exposure Compensation**  
The 540EZ allows the flash exposure to be adjusted independently of the camera, providing a compensation range of  $\pm 3$  stops in 1/3-stop increments.
  - (7) **Manual Flash Control at Eight Output Levels**  
The flash output can be set manually to any of eight power levels, from full (1/1) power to 1/128 power.
  - (8) **Bounce Flash**  
The flash head can be tilted upward or can be swiveled to the right or left for bouncing the flash off of nearby surfaces such as a ceiling or wall to create a softer lighting effect. The flash head can also be tilted 7° downward for close-up shots.
  - (9) **AF Auxiliary Light Corresponding to Five Focusing Points**  
The built-in AF auxiliary light automatically fires in low-light and low-contrast situations to aid the camera's autofocus system. When combined with the EOS-1 N, the AF auxiliary light emission automatically corresponds to the camera's five autofocusing points.
  - (10) **Stroboscopic Flash**  
The 540EZ can be set to automatically fire several flash bursts during a single exposure, creating a stroboscopic effect that records the flow of subject movement. The stroboscopic firing speed can be freely set to frequencies as fast as 100 bursts per second.
  - (11) **Flash Sync Timing**  
The sync timing can be set to either first-curtain sync, which fires the flash as soon as the shutter is fully opened, or second-curtain sync, which fires the flash immediately before the shutter closes.
  - (12) **SE (Save Energy) Function**  
When the flash is set to SE mode, the power automatically turns off after 90 seconds of non-operation in order to conserve battery power.
  - (13) **Rich Selection of External Power Supplies**  
Three types of external power supplies are available, including the Compact Battery Pack E.
  - (14) **System Accessories for Professional Flash Lighting Techniques**  
Canon's line of dedicated flash accessories include the Off-Camera Shoe Cord 2 for separating the flash from the camera, as well as adapters and cords for configuring elaborate multiple-flash setups. Even when using more than one flash, the flash exposure can be controlled automatically by the EOS TTL system.
- ◆ The instructions in this manual assume use with the EOS-1 N camera.
  - ◆ Flash functions and the information displayed in the LCD panel may differ when used with other EOS cameras.
  - ◆ When the 540EZ is used with a camera set to Full-Auto mode or a Programmed Image Control (PIC) mode, all flash functions are controlled by the camera and function settings on the flash unit itself are canceled.

## Precautions

- (1) The 540EZ contains high-voltage circuits. Do not attempt to disassemble the flash unit yourself. Always take it to an authorized Canon service facility for repair.
- (2) The 540EZ is not resistant to water and should not be used outdoors in snow or rain. If momentarily exposed to snow, rain or water spray, immediately wipe water drops from the flash unit's surface with a dry cloth.
- (3) Always slide the 540EZ's power switch to the OFF position after use. If left on, the flash circuitry will drain the battery power.
- (4) Be sure to keep the 540EZ out of direct sunlight, and away from "hot spots" such as the trunk or rear window shelf of a car. Extended exposure to high temperatures can cause the flash unit to malfunction.

● Throughout this manual special precautions relating to the various flash unit operations are enclosed in boxes marked with the following symbols.



: Cautionary measures to ensure proper use and prevent undesired results or malfunction.



: Reference information for helping you gain maximum functionality from the 540EZ.



: Helpful hints for using the 540EZ productively and with maximum efficiency.

## Contents

	Nomenclature .....4	
<b>I. Preparations for Use</b>	1. Loading the Batteries.....5 2. Using an External Power Supply .....6 3. Mounting the Flash .....6 4. Setting the Main Switch .....7	5. Ready Lamp and Test Firing .....7 6. Recycle Time.....8 ● Normal Firing.....8 ● Quick Firing .....8
<b>II. Changing the Flash Settings</b>	1. Flash Coverage Angle (Zoom Button) and Use of the Wide Panel.....8 ● Automatic Zoom Operation .....8 ● Manual Zoom Operation .....9 ● Using the Wide Panel.....9	2. Flash Mode Button .....10 3. Film Speed Setting .....10 4. Display Panel Illumination .....10 5. AF Auxiliary Light.....10
<b>III. Basic Flash Operation</b>	1. Fully Automatic Flash Operation .....11 ● Fill-in Flash For Bright Outdoor Scenes .....12	
<b>IV. Flash Operation in Various Shooting Modes</b>	1. Manual Exposure Mode.....13 2. Aperture-priority AE Mode .....14 3. Shutter-priority AE Mode .....15	4. Slow Synchro Photography .....16
<b>V. Advanced Flash Techniques</b>	1. Flash Exposure Compensation .....17 2. Manual Flash Shooting.....18 3. Stroboscopic Flash.....19 ● Setting the Firing Frequency, No. of Bursts, and Power Level .....20 ● Taking Pictures with Stroboscopic Flash .....20 ● Maximum No. of Continuous Flash Bursts .....21	4. Bounce Flash.....22 ● Catchlight Photography.....23 5. Close-up Flash Photography .....24 6. Second-Curtain Synchronization .....24 7. Multiple Flash Setups .....25 ● Multiple Flash Connection Example .....25 ● 540EZ Functions When Used In A Multiple Flash Configuration.....26
<b>VI. Canon Speedlite 540EZ System</b>	● External Power Supplies .....27 ● Multiple Flash Accessories.....27 Troubleshooting.....28 Specifications .....29	540EZ Function Chart For EOS Cameras .....31 ● Exposure Warnings.....31

# Nomenclature

## ● Front View

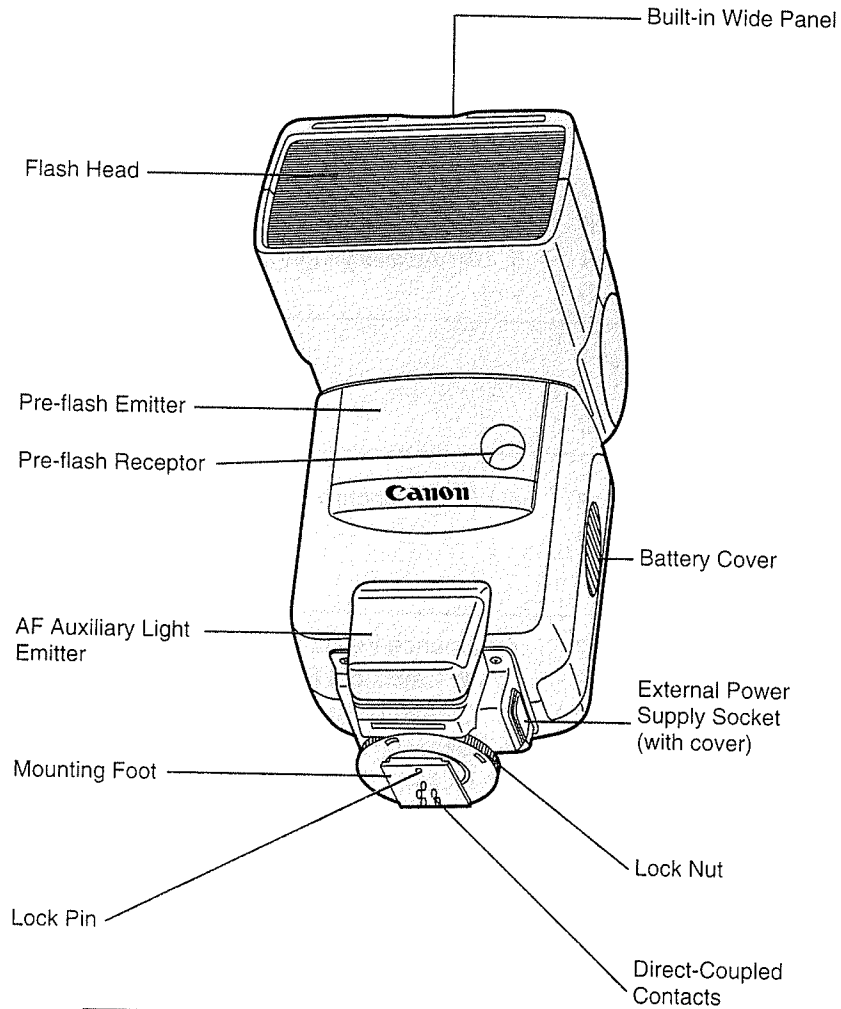

\* A "m/ft" switch is located inside the battery chamber. Use this switch to change the coupling range display units to meters or feet as desired.

## ● Rear View

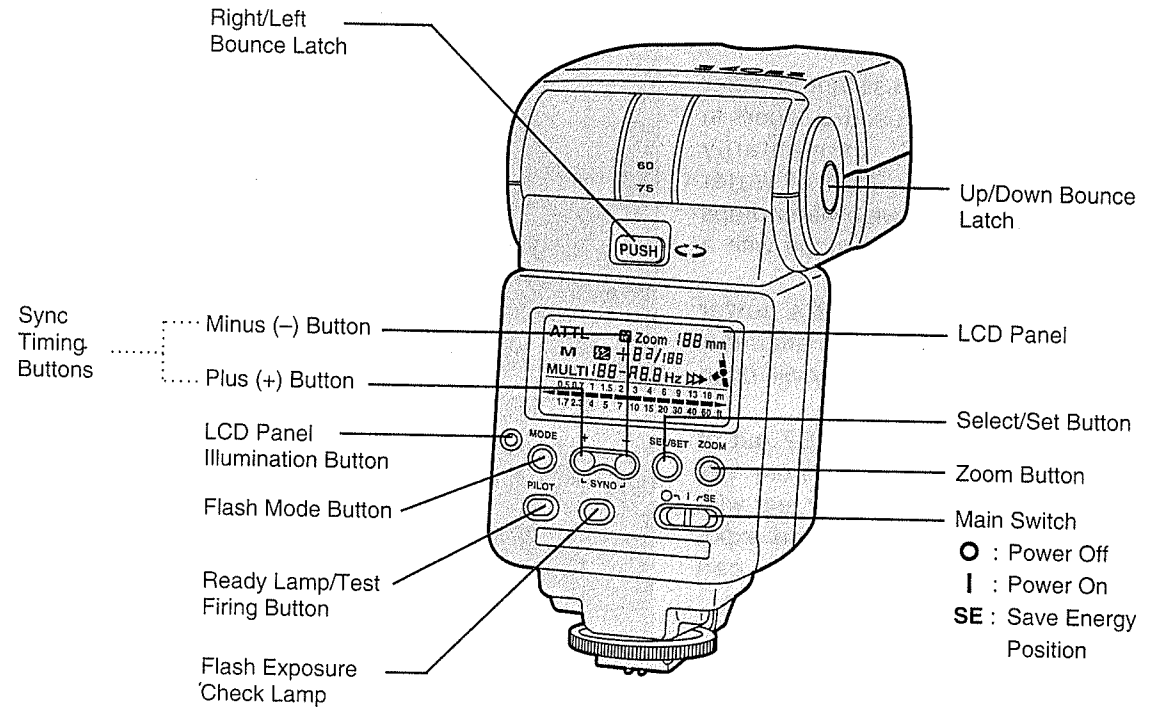

## ● LCD Panel

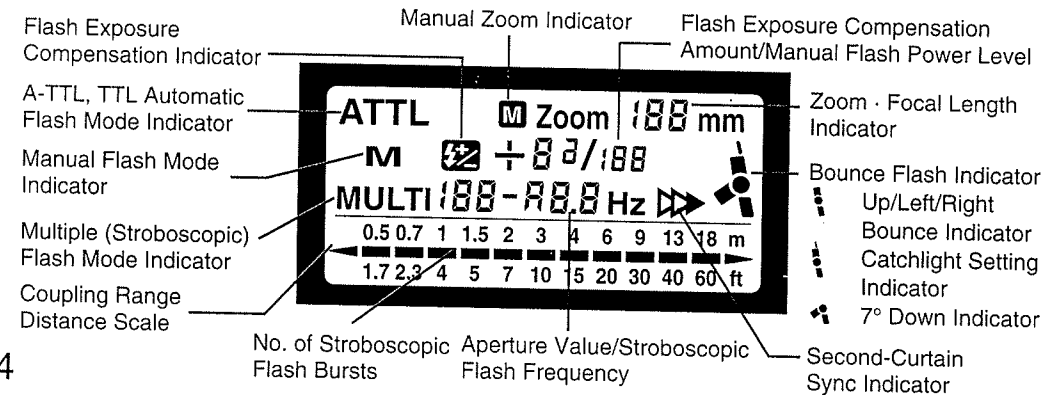

# I. Preparations for Use

## 1. Loading the Batteries

The 540EZ uses four AA-size batteries. Use either of the following battery types:

- (1) Four AA-size alkaline-manganese batteries (LR6/AM-3)
- (2) Four AA-size Ni-Cd batteries (KR15/51)

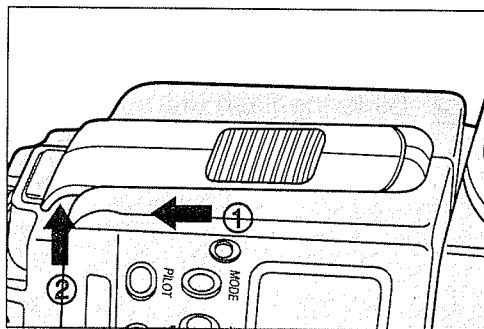

- 1 Open the battery cover by sliding it downward slightly and then swinging it outward.

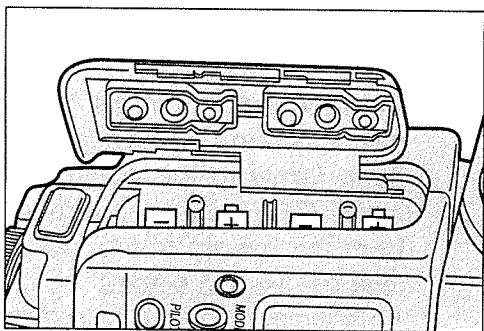

- 2 Load the batteries with their + and - ends oriented as shown in the diagram inside the battery chamber.

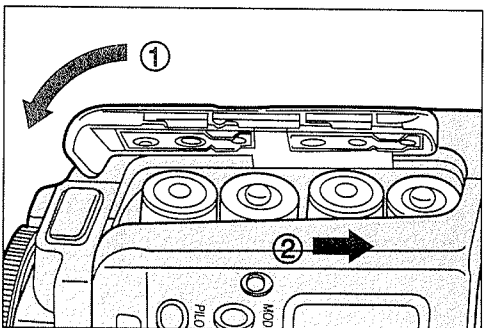

- 3 Close the battery cover.



### Battery Notes

- Use four new batteries of the same type, and always replace all four batteries at the same time.
- AA-size manganese batteries (R6/UM-3) can also be used, but will provide fewer flashes than alkaline-manganese or Ni-Cd batteries.
- The terminals of some AA-size Ni-Cd batteries are of different shape than standard AA-size batteries. Make sure the batteries are usable before purchasing.
- When you will not use the flash for a long period of time, be sure to remove the batteries and store them separately.
- In cold environments, prepare two sets of fully-charged Ni-Cd batteries and keep one set in a warm location such as an inside pocket. When the set in the flash becomes weak, exchange it with the warm set. The weak set can be used again later after it returns to a warmer temperature.
- Dirty battery contacts can prevent the flow of electrical power to the flash circuitry. To prevent corrosion and dirt built-up, wipe the contacts with a clean cloth each time you exchange the batteries.
- AA-size lithium batteries (FR6) can also be used in the 540EZ.

### Battery Life and Recycle Time:

Battery type	Battery life (No. of bursts)	Recycle time (seconds)	
		Quick flash	Normal flash
AA-size alkaline-manganese (LR6/AM-3)	100~700	0.2 ~ appx. 2	0.2 ~ 13
AA-size Ni-Cd (KR15/51)	45~300	0.2 ~ appx. 1.5	0.2 ~ 7

- \* In the battery life column, figures on the right indicate the number of bursts in A-TTL mode, and figures on the left indicate the number of bursts in manual full-power (1/1) mode.
- \* In the recycle time columns, figures on the left indicate the recycle time in A-TTL mode, and figures on the right indicate the recycle time in manual full-power (1/1) mode.
- \* When using an external power source with the 540EZ, note the following cautions. The battery life will depend on the batteries installed in the 540EZ and not on the external power supply.



### Use of internal batteries with an external power supply—

- Batteries must be loaded in the flash unit even when using an external power supply in order to supply power to the flash circuitry. Make sure batteries are loaded in the flash unit at all times during use.
- When using an external power supply, both the internal batteries and the external power supply are used for flash charging. Accordingly, it is possible that the internal batteries will become exhausted before the external power supply battery. Be sure to always carry a spare set of AA-size batteries for the flash unit.

## 2. Using an External Power Supply

The following external power supplies are available for the 540EZ. For details on use, read the instructions provided with the power supply.

### (1) Compact Battery Pack E

- This external battery pack uses six AA-size alkaline-manganese (LR6/AM-3) or Ni-Cd batteries.

### (2) Transistor Pack E

- This external battery pack uses the Canon Battery Magazine TP, which holds six C-size alkaline-manganese batteries (LR14/AM-2).
- The Ni-Cd Pack TP can also be used.



- Canon recommends that AA-size lithium batteries not be used in this product since its initial high voltage may cause damage to the product.
- Canon recommends the use of Canon-dedicated power packs. Using a non-Canon power pack may cause damage to SPEEDLITE 540EZ.

## 3. Mounting the Flash

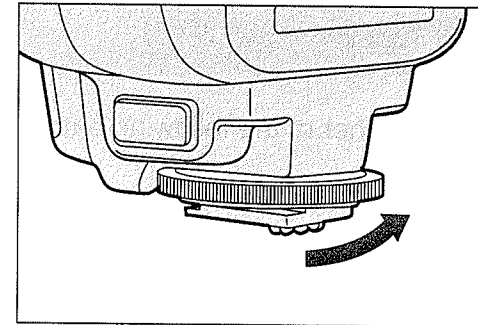

- 1 Turn the lock nut several times in the direction of the arrow to loosen.

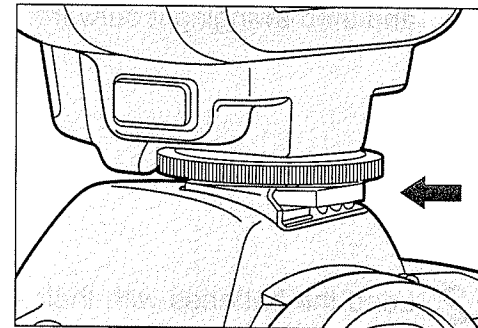

- 2 Slide the flash unit's mounting foot fully into the camera's accessory shoe until it stops.

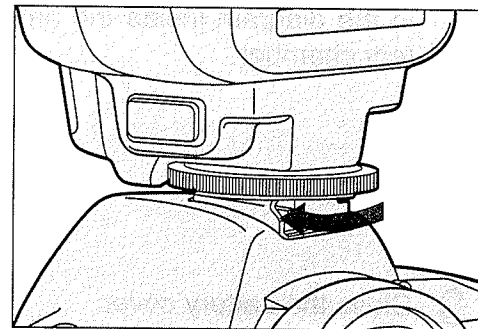

- 3 Turn the lock nut in the opposite direction to secure the flash firmly to the accessory shoe. (The lock pin protrudes from the bottom of the foot to lock the flash in place.)
  - To remove the flash, loosen the lock nut by turning it all the way until it stops, then slide the mounting foot out of the accessory shoe.



Even though lock pin holes are not provided on the EOS 650, EOS 620, EOS 750 or EOS 850, the 540EZ can be mounted without any problem.

## 4. Setting the Main Switch

The main switch has three setting positions, as described below.

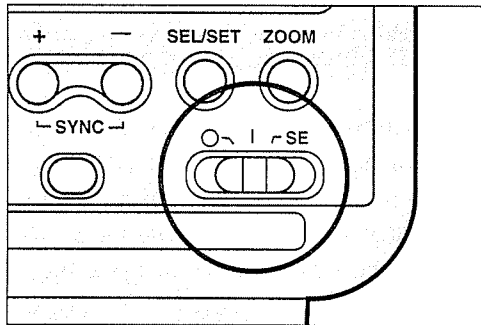

- O** : Turns the power off.
- |** : Turns the power on. The power is always on when the switch is set to this position.
- SE** : Turns the power on and activates the SE (Save Energy) function. The SE function automatically turns off the power after 90 seconds of non-operation to prevent unnecessary battery consumption. The LCD panel display also goes off when the SE function activates. The power comes back on when the camera's shutter button is pressed halfway or the test firing button is pressed.



If the main switch is set to the SE position when using the Command Back E1's interval timer function, power to the flash is automatically turned on one minute before the picture is taken.



### Mode Memory Function

When the power is turned off, the 540EZ's mode memory function automatically memorizes all of the flash unit's settings including the flash mode, zoom position and flash exposure compensation level. When you turn the flash back on, all of the settings are automatically restored to the same state you left them in.

To make sure the mode memory function holds the flash settings in memory when you exchange batteries, first turn off the main switches on both the flash and camera, then exchange the batteries quickly by loading the new batteries within one minute after removing the old batteries.

## 5. Ready Lamp and Test Firing

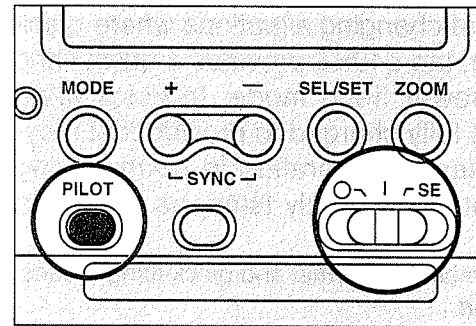

- 1** Turn on the power by setting the flash unit's main switch to the | position.
  - The flash unit starts charging. When fully charged, the ready lamp lights up.

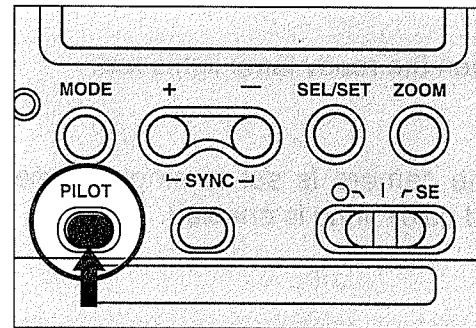

- 2** After the ready lamp lights, press the ready lamp (also used as the test firing button) to make sure the flash fires.



Test firing is not possible while the camera's metering timer is activated after pressing the shutter button halfway.

## 6. Recycle Time

Short recycle times are invaluable in fast-changing situations where quick shooting is necessary. For this purpose, the 540EZ provides a quick firing mode in addition to its normal, full-power firing mode. In quick firing mode, the flash can be fired before it is fully charged to provide fast recycle times. You can tell whether the flash is operating in normal firing mode or quick firing mode by the color of the ready lamp, as described below.

- For details on recycle times and guide numbers in normal and quick firing modes, refer to page n in the Specifications section.

### ● Normal firing

Normal, full-charge firing is possible when the ready lamp lights red.

### ● Quick firing

When the A-TTL mode is set and the camera is set to single-frame shooting, the pilot lamp turns green and quick firing is enabled.



What is a guide number?

The guide number of a flash unit is a numerical indicator of its light output capacity. The appropriate shooting distance or lens aperture required for proper flash exposure can be calculated from the guide number using the following formulas:

Guide number ÷ shooting distance (m) = proper aperture value

Max. shooting distance = guide number ÷ largest lens aperture

- The film speed is usually assumed to be ISO 100 when stating guide numbers. At different film speeds, the guide number increases or decreases accordingly.

## II. Changing the Flash Settings

### 1. Flash Coverage Angle (Zoom Button) and Use of the Wide Panel

The 540EZ incorporates an auto zoom function which automatically sets the flash coverage angle to match the focal length of the lens mounted on the camera. Coverage angles are available for focal lengths ranging from 24mm to 105mm, and the coverage angle automatically changes when the lens is zoomed. The flash coverage angle can be set either automatically or manually. Moreover, a built-in wide panel provides coverage for super-wide-angle focal lengths as short as 18mm.

- When the flash coverage angle is changed, the guide number also changes. The relationship between the flash coverage angle and the guide number is shown on page n in the Specifications section.
- The lens focal length corresponding to the currently set flash coverage angle is displayed in the LCD panel.

### ● Auto Zoom Operation

The flash coverage angle is automatically set according to the focal length of the lens mounted on the camera, and the setting is displayed in the LCD panel. Also, when a zoom lens is used, the flash coverage angle automatically changes when the lens is zoomed, and the new setting is displayed in the LCD panel.

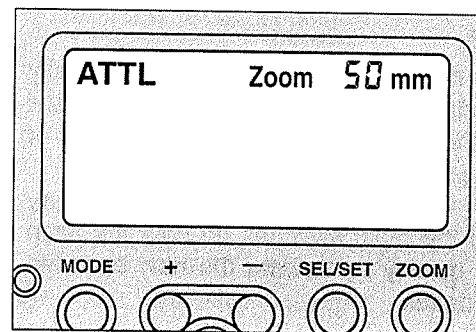

- 1 Turn on the power to the camera.
- 2 Turn on the power to the 540EZ.
  - If  Zoom is displayed in the LCD panel, press the zoom button until only "ZOOM" is displayed.



- 3 When the camera's shutter button is pressed halfway, the setting corresponding to the focal length of the lens in use is displayed in the LCD panel.

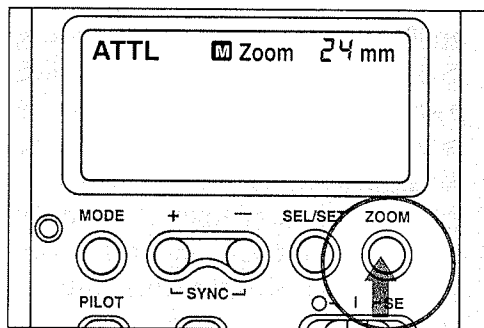

### ● Manual Zoom Operation

To set the flash coverage angle manually, press the zoom button. When the zoom button is pressed, the manual zoom indicator and the ZOOM indicator both appear in the display. Each press of the zoom button changes the coverage angle in the following cycle:

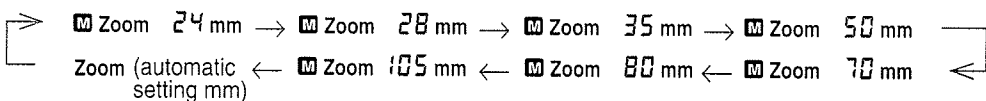

Be careful to select a setting that is equal to or less than the focal length of the lens mounted on the camera. If you select a setting that is larger than the focal length of the lens, the resulting photograph will be dark around the edges.

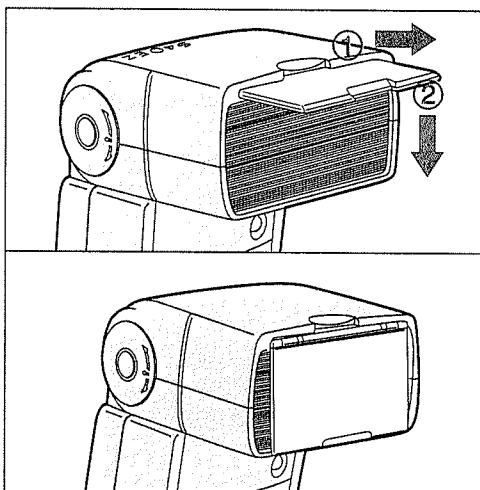

### ● Using the Wide Panel

By pulling out the wide panel and letting it swing down to cover the front of the flash head as shown in the diagram, the flash can be used to cover super-wide-angle focal lengths as short as 18mm.

- The zoom button does not function when the wide panel is in use.
- The wide panel should only be used when the flash head is in the normal (straight ahead) or 7° downward position.

### Warning Indication

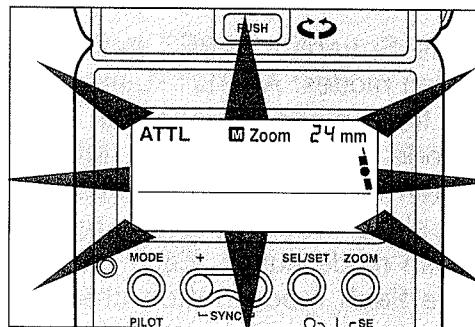

If the flash head is set to a bounce position while the wide panel is being used, both bounced flash and direct flash may illuminate the subject, creating an unnatural effect. If this occurs, the entire LCD panel blinks as a warning to retract the wide panel.



Be careful not to use excessive force when pulling out the wide panel.



- If the wide panel accidentally breaks loose from the flash unit, you will not be able to operate the zoom button. If this occurs, operation of the zoom button can be restored using the following procedure:

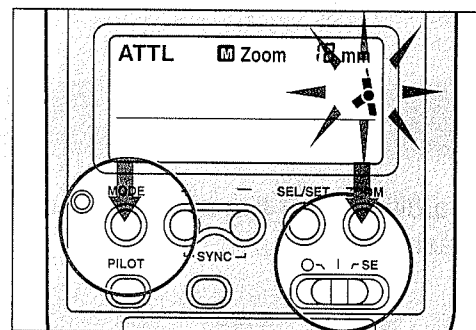

(Display after zoom operation is restored.)

- While simultaneously pressing both the flash mode button and the zoom button, slide the main switch from **O** to **I**, and then to the **SE** position.
- This will restore the zoom button operation, but the bounce indicator will continue to blink in the display. To repair the wide panel, take the flash to your nearest Canon service station.

## 2. Flash Mode Button

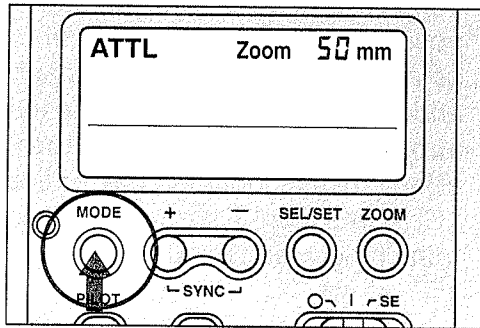

The Speedlite 540EZ has three firing modes: A-TTL/TTL automatic flash mode, Manual (**M**) flash mode, and Stroboscopic (**MULTI**) flash mode. You can select the desired mode by pressing the flash mode button. Each press of the flash mode button changes the flash mode in the following cycle:

→ **A-TTL/TTL** → **M** (Manual flash) → **MULTI** (Stroboscopic flash) →

- A-TTL is automatically set when the camera is set to Full Auto mode, a Programmed Image Control (PIC) mode, Program AE mode, or DEP mode. TTL is automatically set in other camera shooting modes.
- When the flash head is set to a bounce position other than the 7° downward position, the flash mode is set to TTL regardless of the camera shooting mode.

## 3. Film Speed Setting

The film speed is set automatically according to the film speed set on the camera. No setting is required on the flash unit.

## 4. Display Panel Illumination

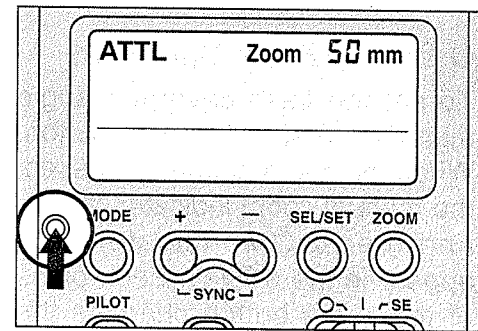

The LCD panel is equipped with an illumination function for viewing in low light. When the display panel illumination button is pressed, the LCD panel lights up for approximately 8 seconds. To turn off the illumination before the 8 seconds elapse, press the display panel illumination button again.

## 5. AF Auxiliary Light

With dark or low-contrast subjects, the flash unit automatically emits an AF auxiliary light to help the camera focus the subject. The 540EZ's AF auxiliary light is designed to correspond to the EOS-1 N's five focusing points. The effective operating range of the AF auxiliary light is 0.5 - 15m / 1.7 - 49.5ft at the center and 0.7 - 6m / 2.3 - 19.8ft at the left and right focusing point positions. Flash coverage is effective for lenses as wide as 28mm.

- Multi-focusing-point EOS cameras with built-in flash units have built-in AF auxiliary lights which override the 540EZ's AF auxiliary light.
- When the 540EZ is used with a camera that has only a single focusing point, only the center AF auxiliary light is used.
- The AF auxiliary light is emitted only when the camera is set to One-shot AF mode.

### III. Basic Flash Operation

After attaching the 540EZ, set your EOS camera to Program AE or Full Auto mode. The camera and flash unit automatically operate in A-TTL program automatic flash mode and the camera automatically sets the appropriate synchronous shutter speed and aperture value. Just like in Full Auto mode, this setting makes flash photography easy for anyone in any situation, from low-light indoor scenes to backlit subjects in daylight.

#### 1. Fully-Automatic Flash Operation

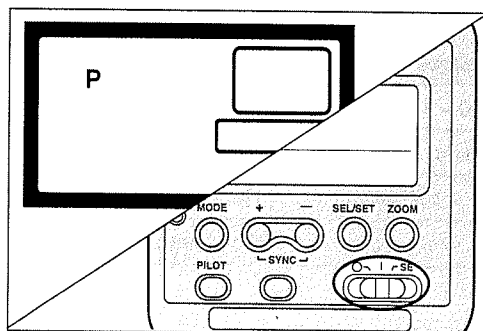

1 Set the camera's shooting mode to Program AE (P).

2 Turn on the power to the Speedlite 540EZ.

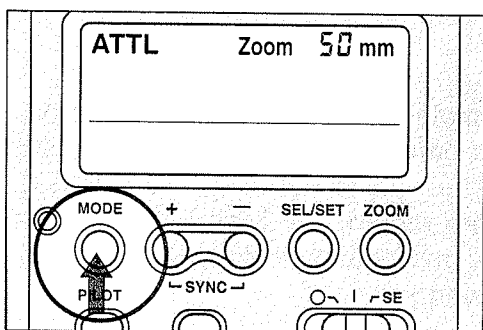

3 Press the 540EZ's flash mode button so that the A-TTL automatic flash mode indicator (A-TTL) appears in the flash unit's LCD panel.



If the flash has been fired 20 times continuously, allow the Speedlite to rest for 15 minutes to prevent the flash head from overheating. Overheating can cause the flash head to breakdown.

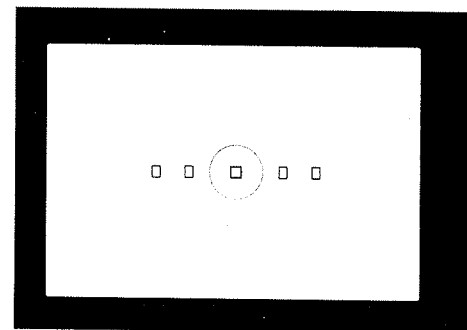

4 Cover the subject with the viewfinder's AF frame and press the shutter button halfway.

- When the shutter button is pressed halfway, the camera focuses the subject and the 540EZ fires a pre-flash to determine the optimum aperture value.
- The camera automatically sets a flash-synchronizing shutter speed of 1/60 ~ 1/250 sec. (the X-sync speed of the camera). The fastest flash-synchronizing shutter speed differs depending on the camera model.

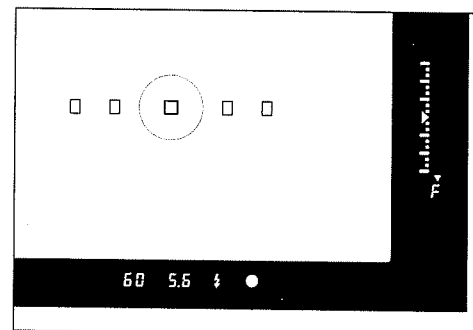

5 After checking that the lightning bolt indicator in the viewfinder lights and the aperture and shutter speed values do not blink, take the picture.



If flash is used in Depth-of-Field AE (DEP) mode, the camera takes a flash picture in the same way as in Program AE mode.

#### Flash Exposure Confirmation

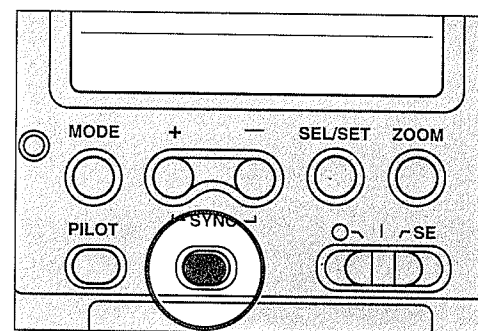

If the flash exposure is correct, the flash exposure confirmation lamp lights for approx. 2 seconds. If the flash exposure confirmation lamp does not light, there is a possibility that the picture was underexposed. In this case, wait for the ready lamp to light red, then take the picture again from a position closer to the subject.

## ● Fill-in Flash For Bright Outdoor Scenes

This is a method for using flash when shooting in daylight. Use the flash as a supplementary light source to soften shadows created by the sun, or to prevent subjects from appearing dark due to being backlit.



When using the 540EZ to shoot a backlit subject in daylight with the camera in a fully automatic mode, the flash output level is automatically reduced to prevent an unnatural imbalance between the flash-lit subject and the naturally-lit background.



With flash



Camera alone (without flash)

## IV. Flash Operation in Various Shooting Modes

TTL automatic flash photography is possible in any shooting mode. Just mount the 540EZ on the camera and select the desired shooting mode. When the camera is set to aperture-priority AE (**Av**), shutter-priority AE (**Tv**) or manual exposure (**M**) mode, the 540EZ automatically operates in TTL automatic flash mode.

- ① When the shutter button is pressed halfway, the camera sets the shutter speed or aperture value in the same way as during normal AE (non-flash) shooting.
  - Depending on the shooting mode, the shutter speed and aperture value are set as follows:

EOS shooting mode	Shutter speed	Aperture value
P, Full Auto mode	Set automatically (1/60 ~ 1/X sec.)	Set automatically
Av (Aperture-priority AE)	Set automatically (30 sec. ~ 1/X sec.)	Set manually
Tv (Shutter-priority AE)	Set manually (30 sec. ~ 1/X sec.)	Set automatically
M (Manual exposure)	Set manually (30 sec. ~ 1/X sec.)	Set manually

- Set manually: Set by you.
  - Set automatically: Automatically set by camera.
  - 1/X sec.: Camera's fastest flash-synchronizing shutter speed (X-sync speed).
- ② When the shutter is pressed completely, the flash fires and the picture is taken. The flash output is controlled by the TTL automatic flash program based on the aperture value set in ①. (During TTL automatic flash control, the camera meters the flash light reflected from the film during the exposure, and automatically stops the flash when the proper exposure is achieved.)
  - ③ The background exposure is determined by the shutter speed and aperture value combination, just as in normal (non-flash) shooting. TTL automatic flash is available in aperture-priority AE (**Av**), shutter-priority AE (**Tv**) and manual exposure (**M**) modes.



Confirming the background exposure with the EOS-1 N and EOS-1:

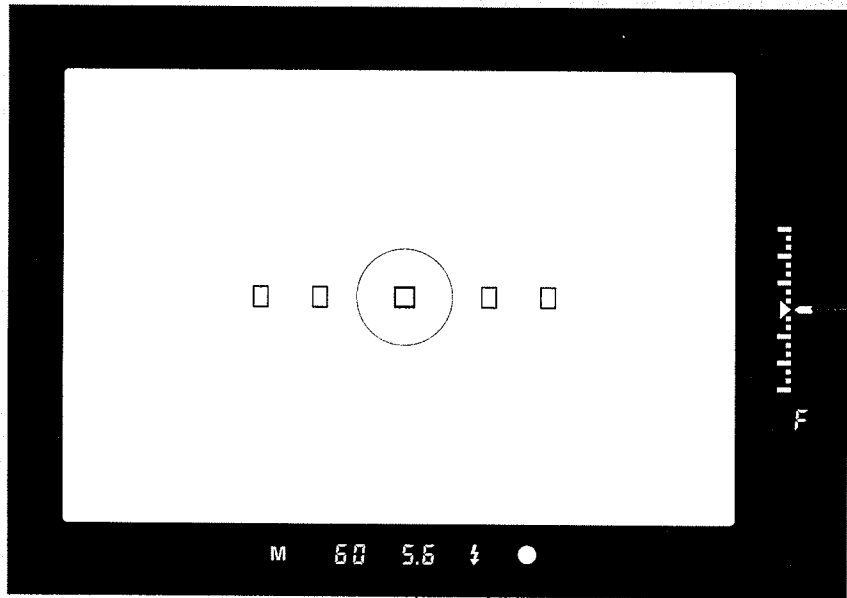

Background exposure •  
Correct exposure indicator

The main subject will be properly exposed by the flash according to the TTL program based on this aperture value.

## 1. Manual Exposure Mode

In this mode, you set both the shutter speed and aperture value as desired. When a picture is taken, the camera and flash unit automatically control the flash exposure according to the TTL program based on the manually-set aperture value.

1 Set the camera's shooting mode to manual exposure mode (M), then set the desired aperture value and a shutter speed between 30 sec. and the camera's X-sync speed.

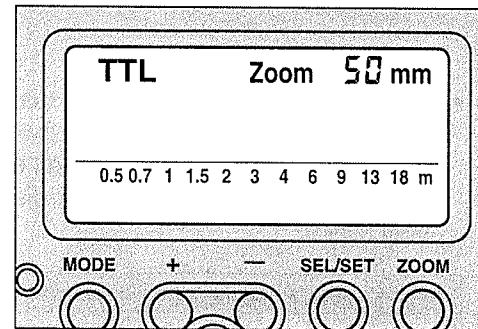

2 Make sure the TTL indicator is displayed in the flash unit's LCD panel.

3 Focus the subject.



- Exposure warnings are given for the background exposure. For the meanings of the warnings, refer to your camera's instruction book.
- The fastest flash-synchronizing shutter speed (X-sync speed) differs depending on the camera model. Refer to the "X-sync Shutter Speeds for EOS Cameras" chart on page 31.
- Even if you set a shutter speed that is faster than the camera's X-sync speed, the camera will automatically reduce the shutter speed to the X-sync speed.



If the flash has been fired 20 times continuously, allow the Speedlite to rest for 15 minutes to prevent the flash head from overheating. Overheating can cause the flash head to breakdown.

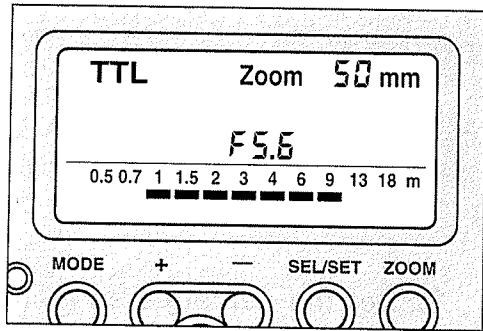

4 Confirm that the distance from the camera to the subject is within the flash coupling distance range displayed in the LCD panel.

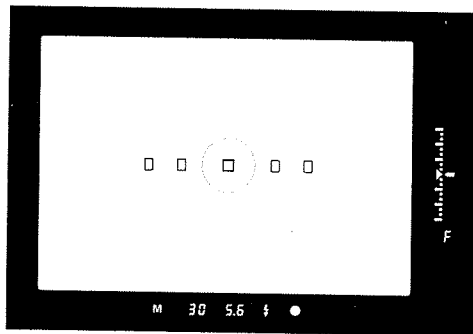

5 Make sure that the flash charge indicator is lit, then take the picture.

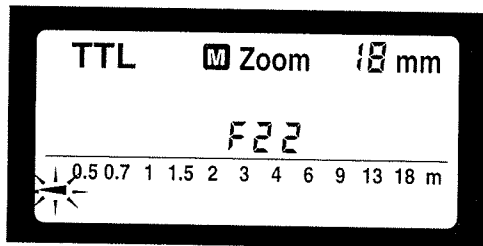

• If the shooting distance is less than the minimum distances shown below, the ◀ indicator at the left of the flash unit's coupling range display blinks.

Flash coverage angle	Shooting distance
18 ~ 28mm	0.5m / 1.7ft or less
35mm or greater	0.7m / 12.3ft or less

## 2. Aperture-priority AE

Use aperture-priority AE mode when using flash for pictures where you need control over depth of field, or when you want to achieve proper exposure of both the subject and background. After manually selecting the desired aperture value, the camera automatically sets the shutter speed necessary to achieve proper background exposure. When the picture is taken, the flash exposure is automatically controlled according to the TTL program based on the manually-set aperture value.

1 Set the camera's shooting mode to aperture-priority AE mode (Av), then set the desired aperture value.

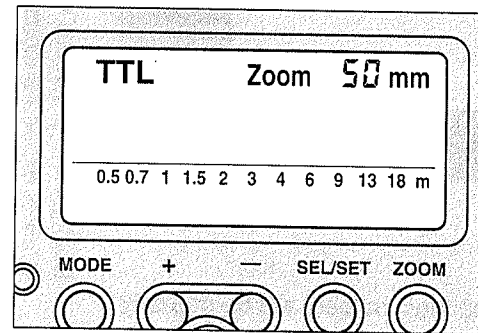

2 Make sure the TTL indicator is displayed in the flash unit's LCD panel.

3 Focus the subject.

4 Confirm that the distance from the camera to the subject is within the flash coupling distance range displayed in the LCD panel.

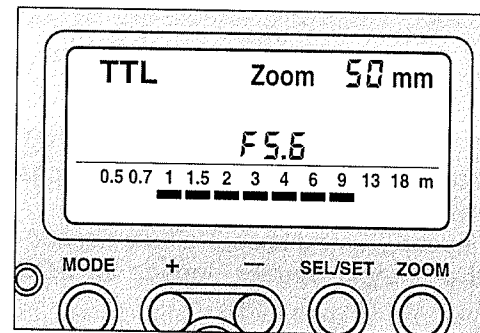

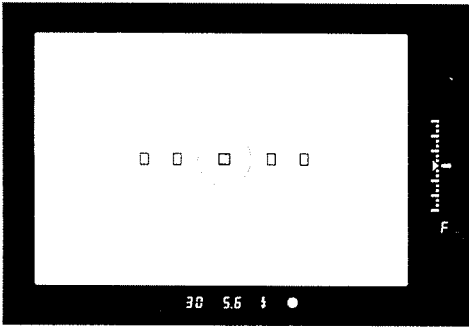

- 5 Make sure the viewfinder's shutter speed display is not blinking and that the flash charge indicator is lit, then take the picture.



In low-light situations, the camera will set a slow shutter speed to ensure proper background exposure. If a slow shutter speed is set, use a tripod to prevent camera shake and make sure the subject does not move during the exposure.



If the shutter speed blinks in the viewfinder, the background will be either overexposed (if the X-sync shutter speed blinks) or underexposed (if 30" blinks). If this occurs, adjust the aperture until the blinking stops.



Certain EOS cameras (EOS RT, EOS 10/10s, and EOS 5/A2/A2E) provide a custom function (CF9) which automatically sets the shutter speed to the camera's maximum synchronization speed (refer to chart on page 31) regardless of the lighting conditions during aperture-priority AE flash photography.

### 3. Shutter-priority AE

Shutter-priority AE mode is useful for flash pictures of moving subjects where different shutter speeds can provide different effects. After manually selecting the desired shutter speed (between 30 sec. and the camera's X-sync speed), the camera automatically sets the aperture value necessary to achieve proper background exposure. When the picture is taken, the flash exposure is automatically controlled according to the TTL program based on the automatically-set aperture value.

- 1 Set the camera's shooting mode to shutter-priority AE mode (Tv), then set a desired shutter speed between 30 sec. and the camera's X-sync speed.

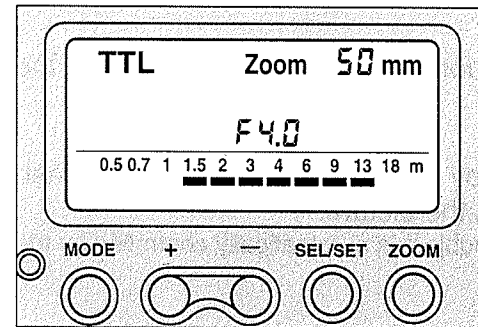

- 2 Make sure the flash is set to TTL mode, then cover the subject with the viewfinder's AF frame and press the shutter button halfway to focus the subject.

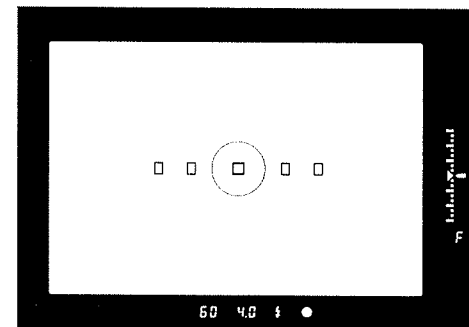

- 3 Confirm that the distance from the camera to the subject is within the flash coupling distance range displayed in the LCD panel, make sure the viewfinder's aperture value display is not blinking and that the flash charge indicator  is lit, then take the picture.



If the aperture value blinks in the viewfinder, the background will be either overexposed or underexposed. If this occurs, change the shutter speed until the blinking stops.

## 4. Slow Synchro Photography

Slow synchro photography is a method combining flash with a slow shutter speed to achieve proper exposure of both the subject and a low-lit background such as a room or night scene. For slow synchro photography with the 540EZ mounted on an EOS camera, use the procedures below.



During slow synchro shooting, use a tripod to prevent camera shake caused by slow shutter speeds.

- 1. Automatic slow synchro photography in aperture-priority AE mode**
  - 1 Set the camera to aperture-priority AE mode (**Av**), and set the desired aperture.
  - 2 Focus the subject.
  - 3 Make sure the viewfinder display is not blinking and that the flash charge indicator is lit, then take the picture.
    - The flash exposure of the main subject is automatically controlled by the TTL automatic flash program.
- 2. Slow synchro photography in manual exposure mode**
  - 1 Set the camera to manual exposure mode (**M**).
  - 2 Focus the subject.
  - 3 Set the shutter speed and aperture to achieve proper background exposure using the camera's exposure level indicators.
  - 4 Make sure the viewfinder display is not blinking and that the flash charge indicator is lit, then take the picture.
- 3. Slow synchro photography in shutter-priority AE mode**
  - 1 Set the camera to shutter-priority AE mode (**Tv**).
  - 2 Focus the subject.
  - 3 Set a shutter speed necessary to achieve proper background exposure using the camera's exposure level indicators.

- 4 Make sure the viewfinder display is not blinking and that the flash charge indicator is lit, then take the picture.
  - If a different aperture setting is desired, change the shutter speed until the desired aperture is set.



Controlling the background exposure with the EOS-1 N and EOS-1:

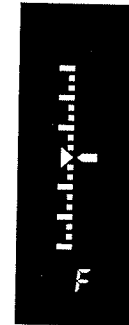

↑ Overexposure

← Correct exposure

↓ Underexposure

The background exposure can be determined by reading the position of the exposure level indicator at the right hand side of the viewfinder.

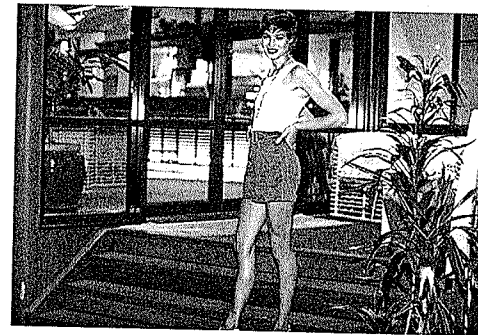

Flash photo taken in aperture-priority AE mode (automatic slow synchro operation)



Flash photo taken in Full Auto mode



# V. Advanced Flash Techniques

## 1. Flash Exposure Compensation

The 540EZ incorporates a feature for compensating the flash exposure independent of the camera exposure. The flash exposure can be compensated up to  $\pm 3$  stops in 1/3-stop increments. By combining this capability with the camera's exposure compensation function, you can fine tune both the background exposure and the flash exposure to achieve a perfect balance.



- If flash exposure compensation is set on both the camera and the 540EZ, the 540EZ's setting will override the camera setting.
- Flash exposure compensation is not possible in Full Auto mode or Programmed Image Control (PIC) modes.

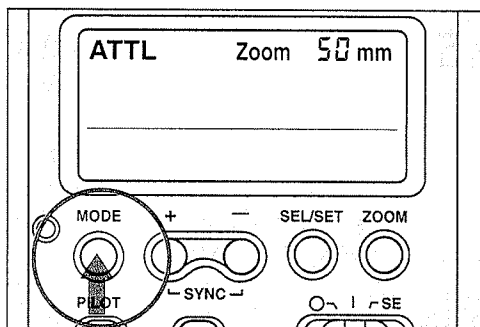

1 Set the flash to automatic flash control mode (A-TTL or TTL).

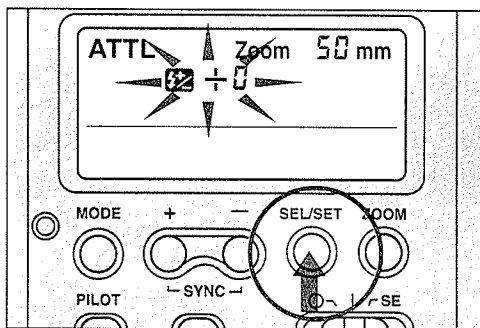

2 Press the Select/Set button.

- The flash exposure compensation indicator (  ) and the compensation value blink in the flash unit's LCD panel.

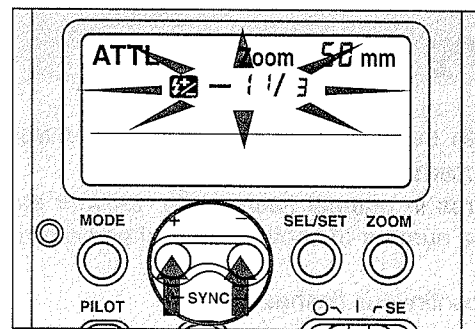

3 While watching the flash unit's LCD panel display, press the plus button or minus button to set the desired flash exposure compensation amount.

- Each press of the plus button or minus button (n) increases or decreases the compensation amount by 1/3 stop.

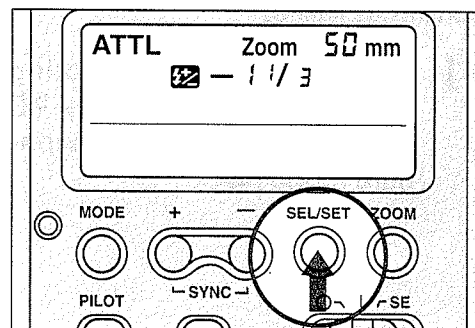

4 Press the Select/Set button again so that the compensation amount stops blinking.

- The compensation amount will automatically stop blinking if 8 seconds elapse before the Select/Set button is pressed.
- Even if a flash picture is taken while the displayed compensation amount is still blinking, the flash exposure will be compensated according to the compensation amount.



If the subject is very small and the background is very dark or far away, proper flash exposure may not be achieved even if flash exposure compensation is used. In a situation such as this, use manual flash.



Effect on exposure of each type of compensation

	Effect
TTL flash exposure compensation	Changes the flash exposure of the main subject.
AE exposure compensation	Changes the exposure of the background.
Compensating the exposure by changing the film speed setting	Changes both the flash (main subject) exposure and the background exposure by the same amount.

## 2. Manual Flash Shooting

The 540EZ provides eight manual flash settings ranging from full power to 1/128 power, adjustable in 1-stop increments.

- When shooting continuous flash exposures in manual flash mode, prevent the flash head from overheating by limiting the number of continuous flashes according to the power setting, as follows:

- (1) 1/1, 1/2 power: Not more than 15 continuous flashes
- (2) 1/4, 1/8 power: Not more than 20 continuous flashes
- (3) 1/16, 1/32 power: Not more than 40 continuous flashes

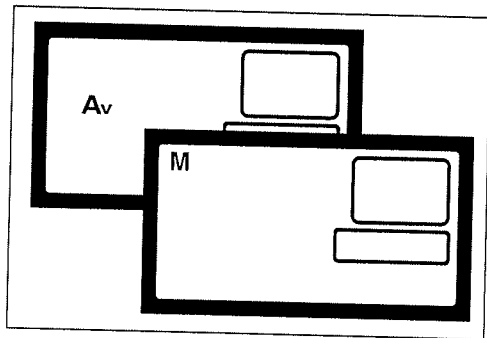

- Set the camera's shooting mode to aperture-priority AE mode (**Av**) or manual exposure mode (**M**).

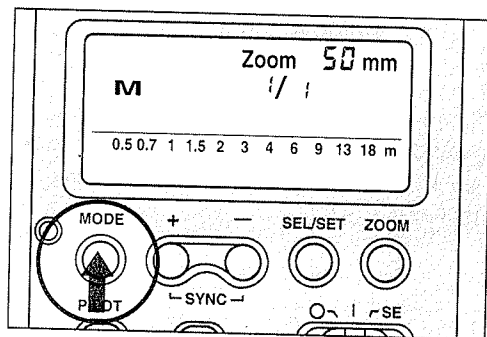

- Set the flash mode to manual (**M**).
  - If a shooting mode other than aperture-priority AE (**Av**) or manual exposure mode (**M**) is set, the minimum aperture value of the lens will blink in the camera's LCD panel when the shutter button is pressed halfway.

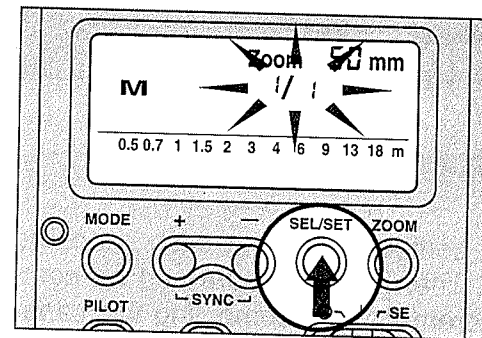

- Press the Select/Set button.
  - The flash output level blinks in the flash unit's LCD panel.

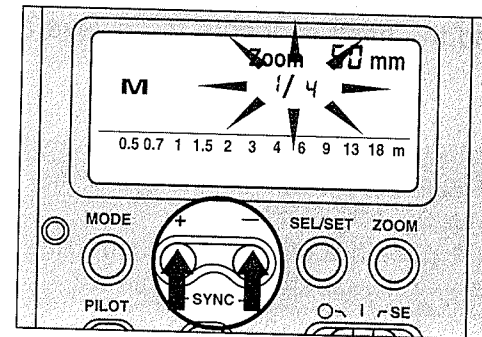

- While watching the flash unit's LCD panel display, press the plus button or minus button to set the desired flash output level amount.
  - Each press of the Plus button or Minus button increases or decreases the output level by 1 stop.

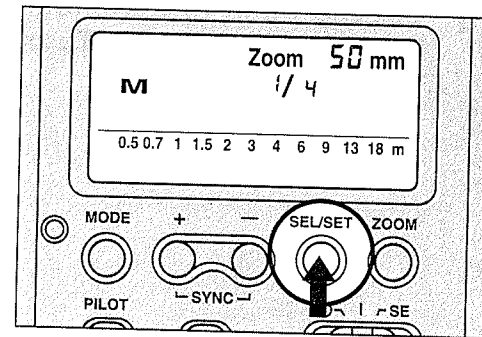

- Press the Select/Set button again so that the output level display stops blinking.
  - The output level will automatically stop blinking if 8 seconds elapse before the Select/Set button is pressed.



If the flash has been fired 15 times continuously at 1/1 or 1/2 power, allow the Speedlite to rest for 15 minutes to prevent the flash head from overheating. Overheating can cause the flash head to breakdown.

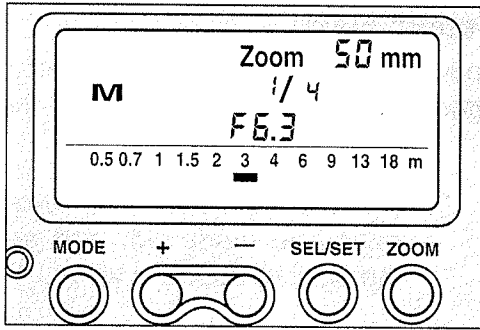

**6** Cover the subject with the viewfinder's AF frame and press the shutter button halfway.

- When the shutter button is pressed halfway, the camera focuses the subject and the flash coupling distance indicator bar and aperture value are displayed in the flash unit's LCD panel.

**7** Check the shooting distance indicated on lens' distance scale.

**8** Check the coupling distance indicator bar in the LCD panel. If there is a difference between the shooting distance (indicated on the lens' distance scale) and the LCD panel's coupling distance indicator bar, adjust the aperture until the coupling distance indicator matches the shooting distance.

- The coupling distance indicator bar can also be adjusted by changing the flash output power level.



- If there is a large difference between the shooting distance and the coupling distance display, change the flash output power level and refocus the subject, then adjust the aperture until the distance indicated on the coupling distance display is the same as the shooting distance.
- For more precise exposure control, use a commercially-available handheld flash meter.

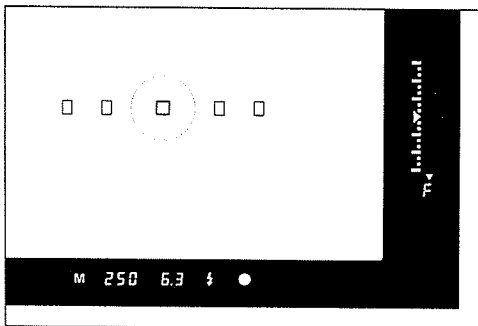

**9** Make sure the shutter speed and aperture value displayed in the viewfinder are not blinking and that the flash charge indicator ⚡ is lit, then take the picture.

### 3. Stroboscopic Flash

The 540EZ's stroboscopic flash function rapidly fires the flash several times in succession during a single exposure to record the flowing motion of a subject.

The stroboscopic firing frequency (measured in number of flash bursts per second, or "Hz") can be set within in a range of 1 Hz ~ 100 Hz. The frequency is set in 1 Hz increments between 1 Hz and 20 Hz, in 5 Hz increments between 20 Hz and 50 Hz, and in 10 Hz increments between 50 Hz and 100 Hz. Up to 100 continuous bursts is possible during a single exposure, but this limit differs depending on the firing frequency and output power level used. For details, refer to the "Maximum No. of Continuous Flash Bursts" chart on page 21.

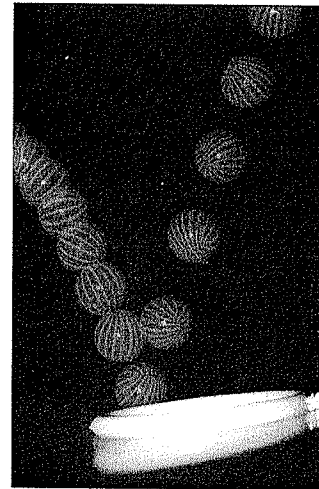

- Use fresh batteries when using stroboscopic flash.
- Stroboscopic flash is not possible at the 1/1 and 1/2 power settings.



- Due to the slow shutter speeds required with stroboscopic flash, we recommend using a tripod and the Remote Switch 60T3.
- We recommend using an external power supply when performing stroboscopic flash photography.



If the stroboscopic flash has been fired 15 times continuously, allow the Speedlite to rest for 15 minutes to prevent the flash head from overheating. Overheating can cause the flash head to breakdown.

## ● Setting the Firing Frequency, No. of Bursts, and Power Level

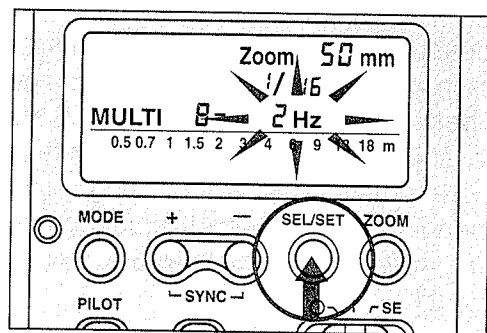

1 Set the flash mode to **MULTI** (stroboscopic flash) mode.

2 Each press of the Select/Set button changes the blinking display in the LCD panel in the cycle shown below. Each number setting can be changed while it is blinking.

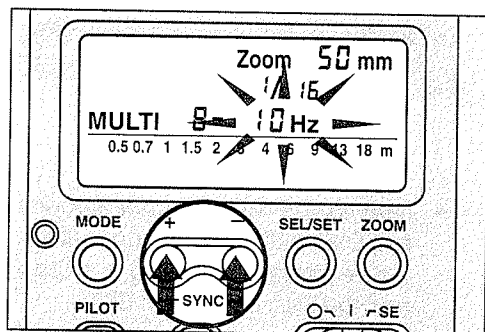
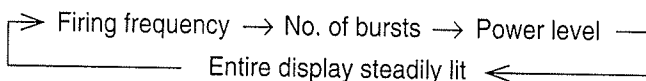

3 Press the Plus button or Minus button to change the blinking number as desired.

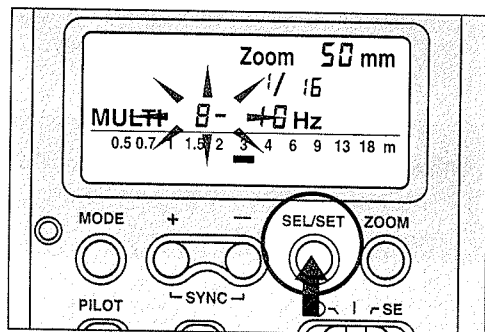

4 Press the Select/Set button again. The current setting stops blinking, and the next setting in the cycle starts blinking.

- The number will automatically stop blinking and be set if 8 seconds elapse before the Select/Set button is pressed.

## ● Taking Pictures with Stroboscopic Flash

When taking pictures with stroboscopic flash, it is necessary to set a shutter speed that will keep the shutter open long enough for all of the flash bursts to be completed.

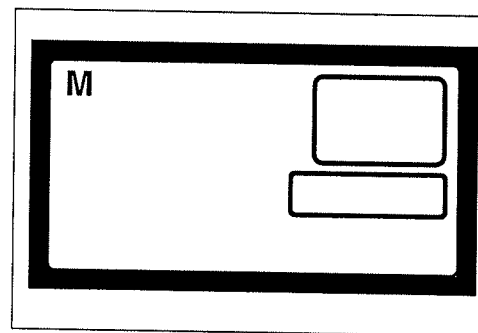

1 Set the camera to manual exposure mode (**M**) and set the desired aperture value.

2 Set the shutter speed calculated from the following formula:

Shutter speed =

No. of bursts ÷ Firing frequency

For example, if the number of bursts is set to 10 and the firing frequency is set to 5 (Hz),  $10 \div 5 = 2$ , so the shutter speed should be set to a speed of 2 seconds or longer. To make sure all of the flash bursts are properly recorded, it is a good idea to set a shutter speed that is slightly longer than the calculated speed. In this case, for example, a shutter speed of 4 seconds would be appropriate.

- If the number of bursts is set to -- (unlimited), the flash will continuously fire until the shutter closes or until the flash charge is depleted. However, the maximum number of continuous flash bursts is limited to the number shown in the chart on page 21.

3 Focus the subject.

- To determine the flash exposure, follow the manual flash procedure on page 18.

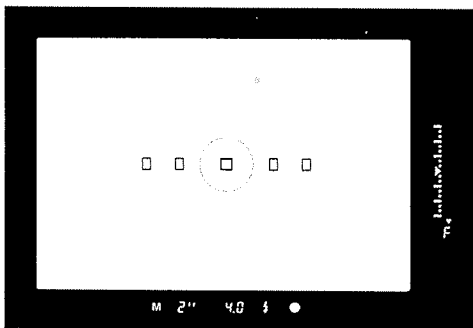

4 Make sure the shutter speed and aperture value displayed in the viewfinder are not blinking and that the flash charge indicator  is lit, then take the picture.



- Stroboscopic flash is also possible in bulb mode.
- We recommend using a tripod during stroboscopic flash shooting to prevent camera shake.
- Best effect can be achieved by using a bright, highly reflective subject against a dark background.

### ● Maximum No. of Continuous Flash Bursts

Output level \ Hz	1	2	3	4	5	6	7	8	9	10
1/4	7	6	5	4	4	3	3	3	3	2
1/8	14	14	12	10	8	6	6	5	5	4
1/16	30	30	30	20	20	20	20	10	10	8
1/32	60	60	60	50	50	40	40	30	30	20
1/64	90	90	90	80	80	70	70	60	60	50
1/128	100	100	100	100	100	90	90	80	80	70

Output level \ Hz	11	12	13	14	15	16	17	18	19	20
1/4	2	2	2	2	2	2	2	2	2	2
1/8	4	4	4	4	4	4	4	4	4	4
1/16	8	8	8	8	8	8	8	8	8	8
1/32	20	20	20	20	18	18	18	18	18	13
1/64	40	40	40	40	35	35	35	35	35	30
1/128	70	70	70	70	50	50	50	50	50	40

Output level \ Hz	25	30	35	40	45	50	60	70	80	90	100
1/4	2	2	2	2	2	2	2	2	2	2	2
1/8	4	4	4	4	4	4	4	4	4	4	4
1/16	8	8	8	8	8	8	8	8	8	8	8
1/32	16	16	16	16	16	16	12	12	12	12	12
1/64	30	30	30	30	30	30	20	20	20	20	20
1/128	40	40	40	40	40	40	40	40	40	40	40

- When the number of bursts is set to -- (unlimited), the maximum number of bursts is as shown in the following table, regardless of the firing frequency.

Output level	1/4	1/8	1/16	1/32	1/64	1/128
Max. no. of bursts	15	20	50	70	100	160

## 4. Bounce Flash

To prevent the harsh background shadows that are often created when the flash is fired directly at the subject, try directing the flash at the ceiling or a wall so that the softer, reflected light illuminates the subject for a more natural effect. This technique is called “bouncing the flash”.



Bounce flash



Direct flash

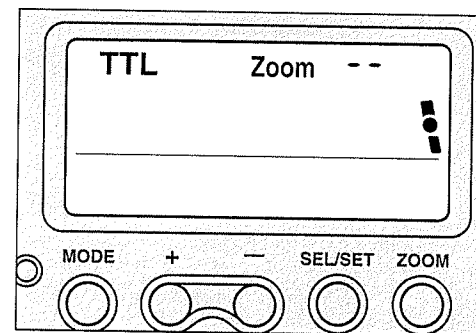
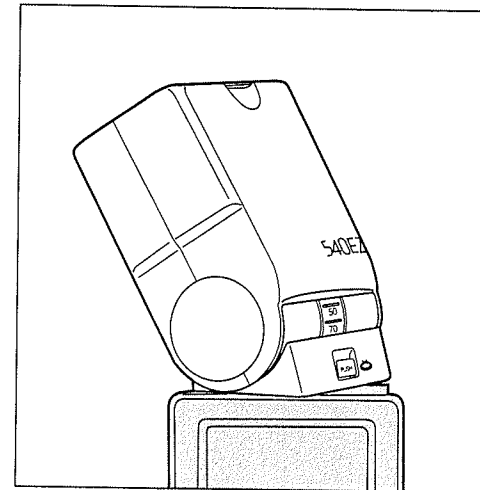
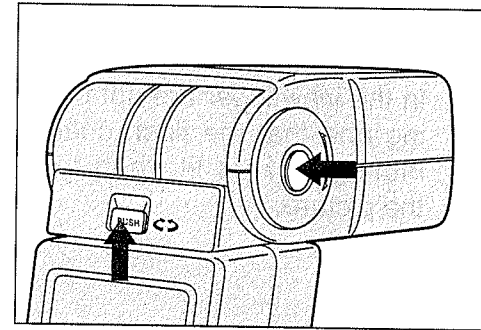

1 Press the left/right bounce latch or up/down bounce latch and direct the flash head at a reflective surface such as a wall or ceiling. The flash head can be rotated both vertically and laterally to achieve the optimum bounce position.

- The flash head can be rotated to the following angles, with 0° defined as the straight-ahead position.

Direction	Maximum rotation angle	Click stops
Up	90°	0°, 60°, 75°, 90°
Left	180°	0°, 60°, 75°, 90°, 120°, 150°, 180°
Right	90°	0°, 60°, 75°, 90°

2 When the flash head is rotated to a bounce position, the bounce indicator (  ) lights in the LCD panel.

- If the flash is set to auto zoom mode when the flash head is rotated to a bounce position, the coverage angle is automatically set to 50mm. The zoom position can also be set manually to any desired coverage angle.

3 Cover the subject with the viewfinder's AF frame and press the shutter button halfway.

4 Make sure the shutter speed and aperture value displayed in the viewfinder are not blinking and that the flash charge indicator  $\text{⚡}$  is lit, then take the picture.

- After taking a picture with bounce flash, the flash exposure check lamp will light for approx. 2 seconds if correct exposure was achieved. If the flash exposure check lamp does not light, the subject was underexposed: Set a larger aperture and take the picture again.



For best effect, bounce the flash off of a highly-reflective, solid white (or off-white) surface. If the surface is colored or patterned, the reflected light will pick up the color or pattern and will adversely affect the photograph.

### ● Catchlight Photography



A “catchlight” is a point of light reflected in the subject’s eyes which adds life to the photograph. When taking portrait shots with bounce flash, the 540EZ’s built-in wide panel can be used as a reflector to provide a catchlight effect.

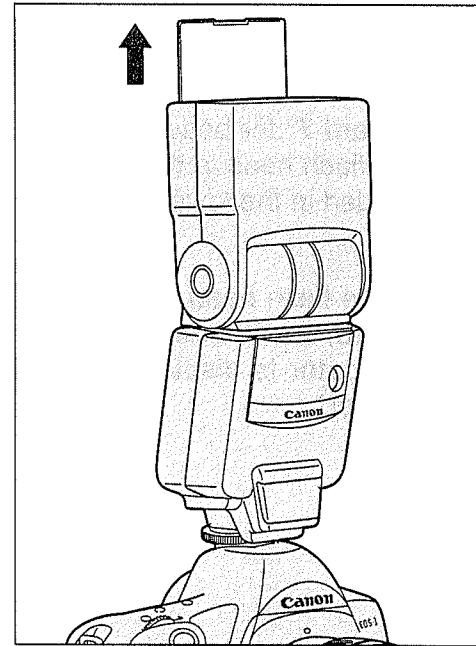

Rotate the flash head upward to the vertical 90° position, then pull the wide panel out of its housing until it locks in place at the click position. After that, the procedure is the same as for normal bounce flash photography.



- The catchlight effect will not be produced if the flash head is rotated to the left or right. The catchlight panel should only be used with the flash head in the 90° upward bounce position.
- To effectively produce the catchlight in the subject’s eyes, make sure the subject is within 1.5m / 5ft from the camera.

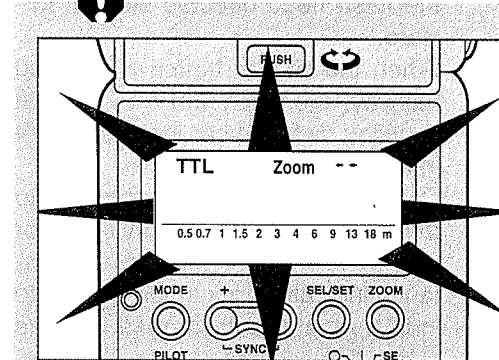

If the flash head is angled 7° downward while the wide panel is set to the catchlight position, the entire LCD panel will blink to warn you that the bounce position is incorrect. Rotate the flash head to the 90° upward bounce position.

## 5. Close-up Flash Photography

The 540EZ's flash head can be angled downward 7° for better flash coverage in close-up shooting situations. With the flash head in the 7° downward position, sufficient flash coverage is provided in the lower part of the scene when shooting at close distances.

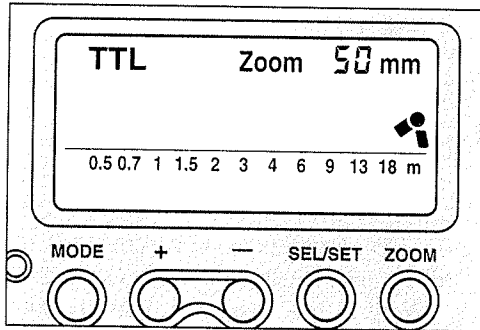

When the flash head is angled 7° downward, the 7° downward position indicator is displayed in the LCD panel.

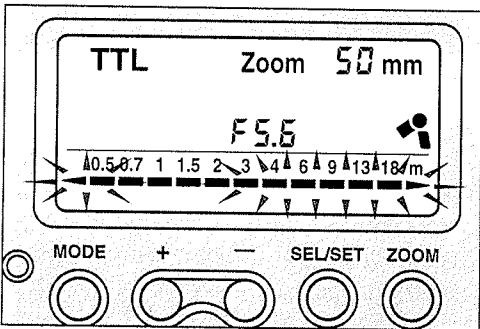

- The 7° downward position is effective only for close shooting distances of 0.5 ~ 2m / 1.7 ~ 6.6ft with the flash head directed straight forward.
- When the shutter button is pressed halfway, the 0.5 ~ 2m / 1.7 ~ 6.6ft coupling distance bar indicators light in the LCD panel.
- Coupling distance bar segments to the right of the 2m / 6.6ft indicator and to the left of the closest distance indicator blink in the display to indicate that the flash head is in the close-distance shooting position.
- If the coupling distance falls outside of the 0.5 ~ 2m / 1.7 ~ 6.6ft range, all of the coupling distance bar segments blink to warn you that the shooting distance is inappropriate for the flash head setting.

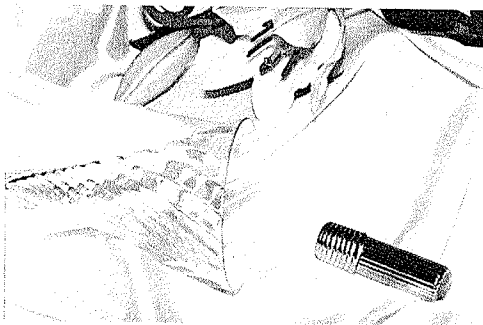
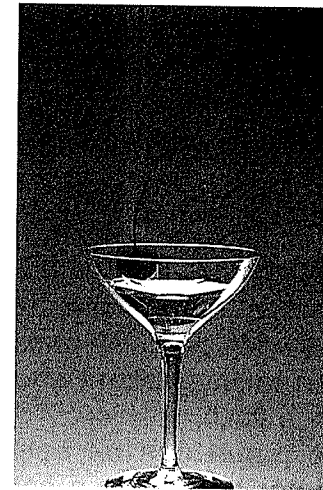

Photo taken with flash head directed 7° downward

## 6. Second-Curtain Synchronization

When the 540EZ is used with an EOS camera, you can select whether to have the flash fire as soon as the shutter opens (first-curtain sync) or immediately before the shutter closes (second-curtain sync).

When using a slow shutter speed with a moving subject, second-curtain synchronization will provide a more natural effect because the flash exposure occurs at the end of the subject movement rather than at the beginning, providing a “trailing blur” effect that emphasizes motion.



Second-curtain sync

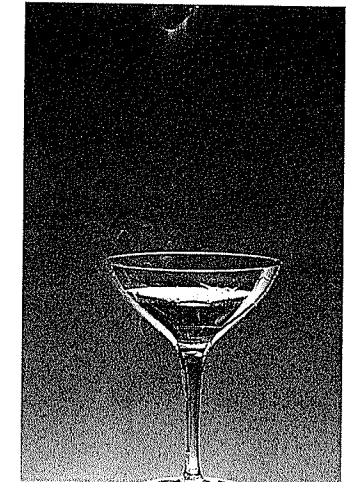

First-curtain sync



- Second-curtain sync flash photography is not available in Full Auto (□) or Programmed Image Control (PIC) modes.
- Second-curtain sync cannot be combined with stroboscopic flash operation.





Setting the camera's shooting mode to bulb makes it easier to produce effective second-curtain sync flash shots.

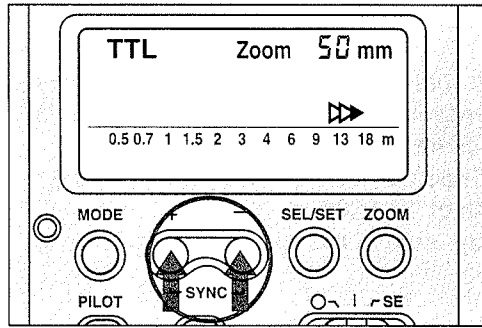



To set the 540EZ to second-curtain sync mode, press the Plus button and Minus button simultaneously.

- The second-curtain sync indicator  appears in the LCD panel and the flash enters second-curtain sync mode.
- Each time the Plus and Minus buttons are simultaneously pressed, the synchronization mode alternates between first-curtain sync and second-curtain sync. When first-curtain sync is selected, the second-curtain sync indicator  disappears from the display.

## 7. Multiple Flash Setups

Use of several flash units positioned effectively at different angles to the subject can produce a more balanced, three-dimensional lighting effect than can be achieved with a single, on-camera flash unit. With Canon's optional multiple flash accessories, easy TTL automatic flash exposure control is possible even with several flash units, eliminating the need for difficult exposure calculations. All of Canon's EZ Series and E Series speedlites, as well as the 480EG grip-type speedlite and the ML-3 Macro Ring Lite, can be used in multi-flash setups comprising as many as four flash units.

### ● Multiple Flash Connection Example

 Second-curtain sync cannot be set or canceled while flash settings are blinking in the display after the Select/Set button is pressed. To set or cancel second-curtain sync in this condition, first press the Select/Set button until the flash settings stop blinking.

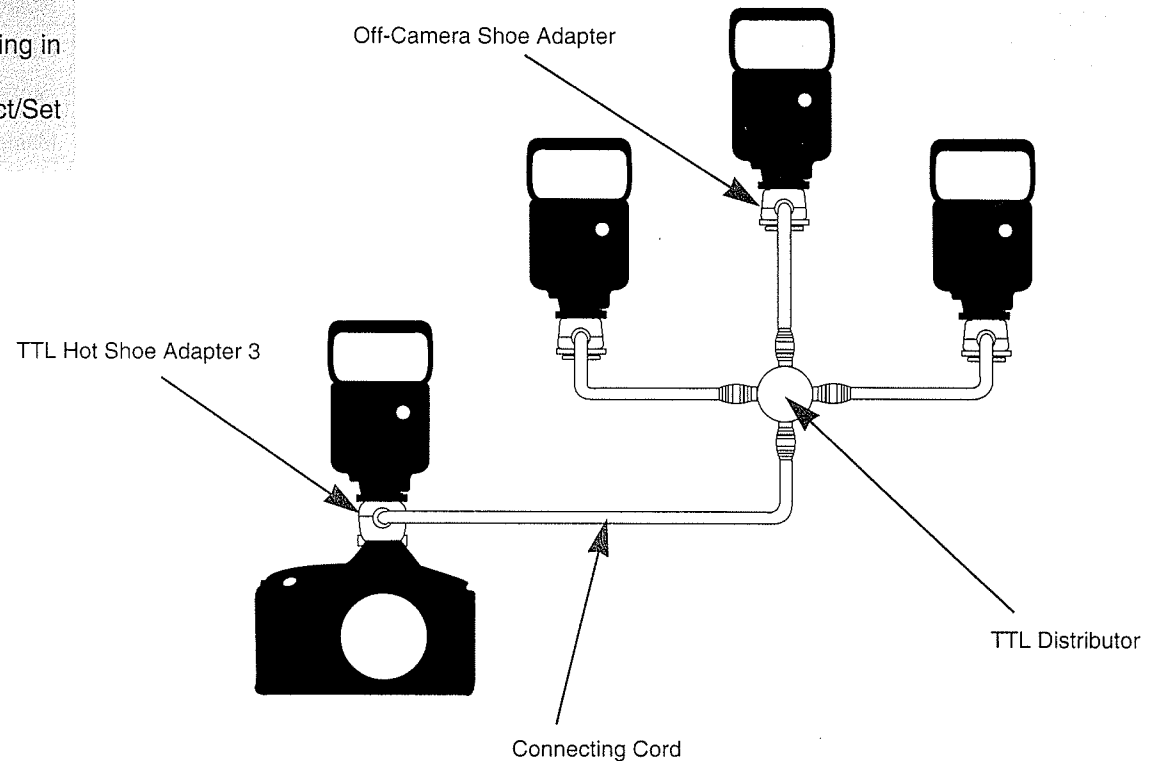

- 1 Connect the flash units to the camera using the appropriate multi-flash accessories.
- 2 After confirming that each flash unit is in the state described below, take the picture.
  - (1) The ready lamp is lit.
  - (2) The flash mode is set to TTL (or A-TTL).

◆ Below is an example of a practical multiple flash configuration.

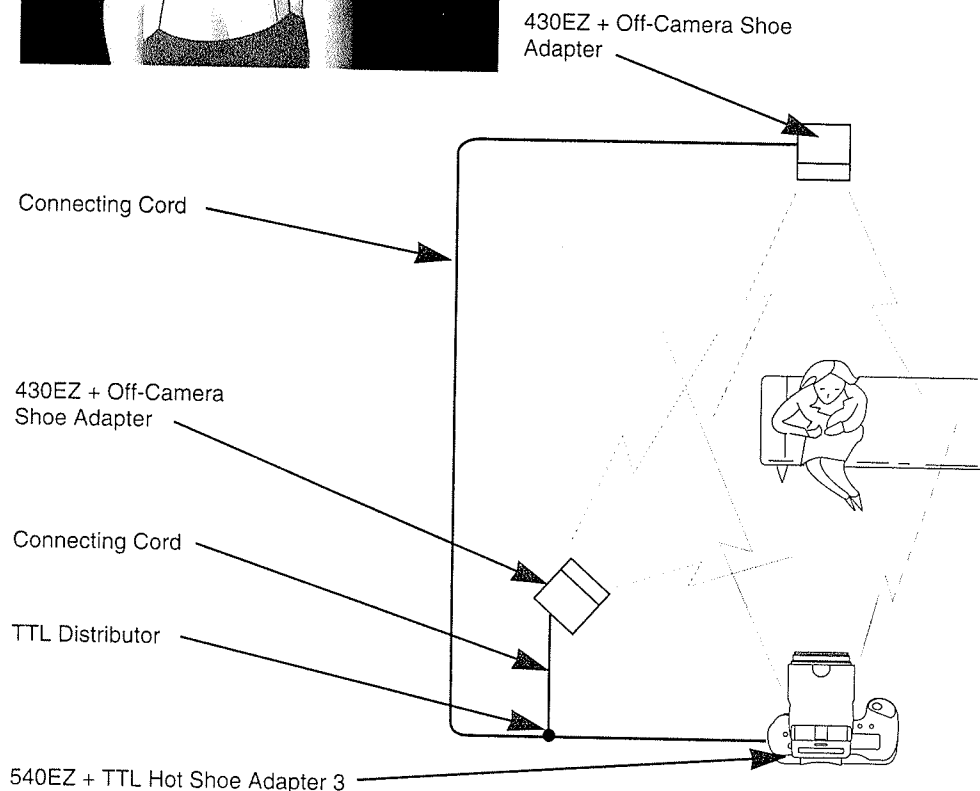

- If the TTL Hot Shoe Adapter 3's built-in battery becomes depleted, the flash charge completion signal will not be transmitted and the flash will not fire. Be sure to check the battery level of the TTL Hot Shoe Adapter 3 before use.
- If a cord extension is necessary, up to three connecting cords can be connected end-to-end for a maximum total length of 9m / 30ft.
- If the flash units are set to manual mode, normal manual flash firing is possible.

### ● 540EZ Functions When Used In A Multiple Flash Configuration

540EZ Function	Normal flash operation	Multiple flash operation
A-TTL automatic flash control	●	× Note 1
TTL automatic flash control	●	●
Flash coupling range display	●	×
Flash exposure confirmation indicator	●	●
540EZ-based flash exposure compensation	●	× Note 2
Manual firing/output level control	●	●
Stroboscopic flash/condition settings	●	●
Second-curtain synchronization	●	× Note 3
Auto zoom	●	×
A-TTL infrared pre-flash	●	×
AF auxiliary light emission	●	×
SE function when SE is selected	●	●

Note 1: Even if the A-TTL indicator is displayed in the LCD panel, the 540EZ will operate in TTL mode.

Note 2: If flash exposure compensation is set on the 540EZ, the flash exposure compensation indicator will appear in the LCD panel but the flash output will not actually be compensated. In multiple flash setups, flash exposure compensation must be performed on the camera side.

Note 3: Even if the second-curtain sync indicator is displayed in the LCD panel, the 540EZ will operate in first-curtain sync mode.

## VI. Canon Speedlite 540EZ System

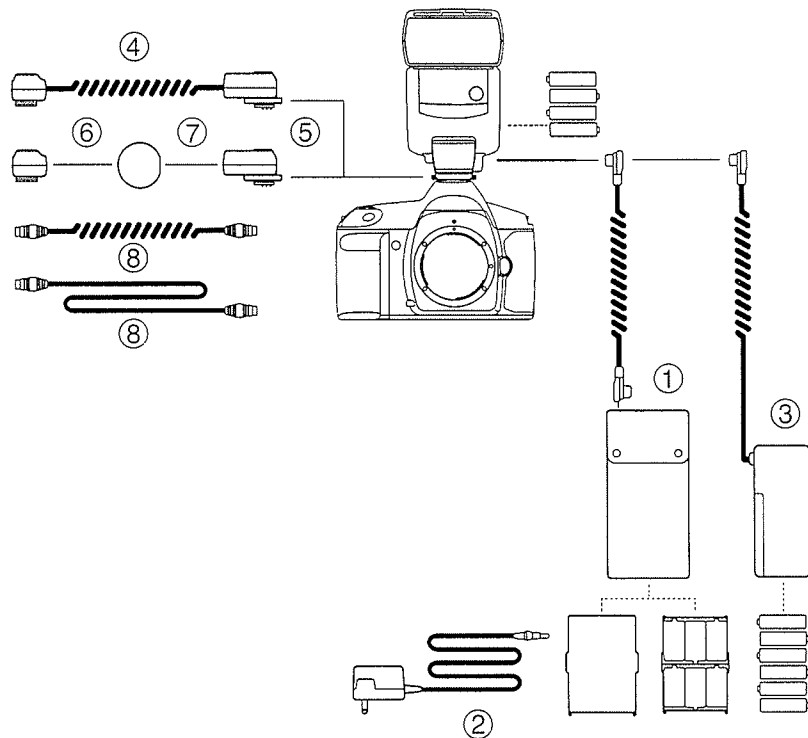

### ● Multiple Flash Accessories

- ④ Off-Camera Shoe Cord 2  
This accessory lets you separate the flash approximately 60cm / 2ft from the camera while maintaining all of the EOS automatic flash functions.
- ⑤ TTL Hot Shoe Adapter 3  
This adapter is equipped with two sets of direct-coupled contacts as well as a connecting cord socket. By mounting this adapter between the camera's accessory shoe and the flash unit, a connecting cord can be used to add additional speedlites using the Off-Camera Shoe Adapter or the TTL Distributor.
- ⑥ Off-Camera Shoe Adapter  
This adapter is equipped with one set of direct-coupled contacts and a connecting cord socket. A tripod socket is provided on the base of the adapter to facilitate off-camera mounting. A flash unit attached to the direct-coupled contacts can be connected to the TTL Hot Shoe Adapter 3 or TTL Distributor via a connecting cord.
- ⑦ TTL Distributor  
This adapter has four connecting cord sockets. By connecting one socket to the TTL Hot Shoe Adapter 3 and the other three sockets to Off-Camera Shoe Adapters, multi-flash configurations comprising up to four flash units are possible.
- ⑧ Connecting Cord 60, Connecting Cord 300  
These cables are used to connect multiple flash setups and are available in two lengths: 60cm / 2ft and 300cm / 10ft.

### ● External Power Supplies

- ① Transistor Pack E with Battery Magazine TP and Connecting Cord E  
This external power supply uses six C-size alkaline-manganese batteries, six C-size Ni-Cd batteries or a dedicated Ni-Cd battery pack. When using C-size alkaline-manganese or Ni-Cd batteries, the batteries are inserted into the supplied Battery Magazine TP, which is then loaded into the Transistor Pack E main unit.
- ② Ni-Cd Pack TP, Ni-Cd Charger TP  
The Ni-Cd Pack TP is a dedicated battery pack for use with the Transistor Pack E which enables quick firing with fast recycle times. The Ni-Cd Charger TP is a dedicated charger for recharging the Ni-Cd Pack TP which provides a full charge in approx. 15 hours.
- ③ Compact Battery Pack E  
This is a small, lightweight external battery pack that uses six AA-size alkaline-manganese batteries or six AA-size Ni-Cd batteries.

# Troubleshooting

Number	Symptom	Cause	Cure	Reference page
1	The flash unit cannot be removed from the camera.	The lock nut was not loosened enough to release the lock pin.	Loosen the lock nut until the lock pin pulls completely out of the hole.	6
2	The flash does not fire even if the shutter button is pressed.	The flash is not mounted completely or securely onto the camera's accessory shoe.	Mount the flash unit securely onto the accessory shoe.	6
		The contacts on the camera's accessory shoe are dirty, or the contacts on the flash foot are dirty.	Wipe the contacts clean with a clean cloth.	6
3	The flash unit's entire LCD panel display goes off while the power is still turned on.	The main switch is set to "SE". At the SE position, the power automatically turns off after 90 seconds of inactivity.	Change the main switch setting to I, or press the shutter button halfway to reactivate the power.	7
4	The entire display blinks when the main switch is turned on.	The wide panel is protruding slightly from its housed position.	Make sure the wide panel is fully retracted.	9
		The flash head is set to a bounce position with the wide panel still in place.	Make sure the wide panel is retracted.	9
5	The coupling distance range display blinks when the shutter button is pressed halfway.	The flash head is in the 7° downward position.	When not shooting at a close distance, set the flash head to a position other than the 7° downward position.	23
6	The flash does not fire even though it is connected to an external power supply loaded with new batteries.	There are no batteries loaded in the 540EZ, or else the 540EZ's batteries are depleted.	Make sure fresh batteries are loaded in the 540EZ even when using an external power supply.	5
7	Even though the flash is connected to an external power supply loaded with new batteries, the zoom mechanism moves by itself or the LCD panel display goes off after the main switch is turned on.	The 540EZ's internal batteries are depleted. To check the battery condition, disconnect the external power supply and measure the recycle time with the internal batteries alone. If the ready lamp does not light within 30 seconds after turning on the power, the batteries are depleted.	Replace the 540EZ's internal batteries with new ones.	5
8	A dark strip appears at the bottom of a flash photograph.	The shooting distance was too close.	When taking pictures of subjects closer than 2m / 6.6ft, set the flash head to the 7° downward position.	24
9	In a photograph composed with the subject positioned near the edge of the picture, the subject is overexposed by the flash.	Flash control for the subject exposure was not performed well.	When using an EOS camera with multiple AF points, first compose the picture and then focus the subject using a manually selected focusing point. When using an EOS camera with only one AF point, compensate the flash exposure by an appropriate amount in the minus direction.	17
10	When taking a flash picture of a subject standing in front of a glass window, the subject's face turned out dark in the photograph.	Bright light reflected from the window glass caused the subject to be underexposed.	Either take the picture from a position where the reflected flash light will not enter the camera lens, or compensate the flash exposure by an appropriate amount in the plus direction.	17
11	When taking a flash picture of a subject dressed in black, the subject's face turned out very white in the photograph.	Due to the low reflectance of the black clothes, the overall exposure overexposed the subject's face.	Compensate the flash exposure by an appropriate amount in the minus direction.	17
12	Flash photographs appear dark around the edges.	The manually-set flash coverage angle did not sufficiently cover the focal length of the lens in use.	Set the flash coverage angle to auto zoom mode, or manually set the coverage angle to a focal length shorter than the lens in use.	8
13	Flash photographs are generally over- or underexposed.	The 540EZ's flash exposure compensation function was left set.	Turn off the flash exposure compensation.	17

# Specifications

Type	Clip-on type automatic flash unit with direct-coupled contacts (including AF auxiliary light corresponding to 5 focusing points, A-TTL pre-flash, auto zoom and bounce functions)
Guide Number (ISO 100 · m)	(See page 30)
Battery Life and Recycle Times	(See page 30)
Flash Duration	1.2 ms or less during normal firing; 2.3 ms or less during quick firing.
Coverage Angle	<ol style="list-style-type: none"> <li>(1) Auto zoom mode: Automatically set according to focal length of the lens in use (settings: 24, 28, 35, 50, 70, 80, 105)</li> <li>(2) Manual zoom mode: Manually set by pressing the zoom button.</li> <li>(3) Wide panel: Flash coverage for super-wide-angle lenses down to 18 mm is possible by covering the flash head with the built-in wide panel.</li> </ol>
Flash Modes	<ol style="list-style-type: none"> <li>(1) Normal firing;</li> <li>(2) Quick firing;</li> <li>(3) Stroboscopic flash: stroboscopic frequency and no. of bursts each settable in 31 steps;</li> <li>(4) Pre-flash: for measuring A-TTL distance information;</li> <li>(5) Test firing: by pressing the test firing button.</li> </ol>

Flash Head Positions	Direction	Maximum rotation angle	Click stops
	Up	90°	0°, 60°, 75°, 90°
	Left	180°	0°, 60°, 75°, 90°, 120°, 150°, 180°
	Right	90°	0°, 60°, 75°, 90°
	Down	7°	0°, 7°
Exposure Control Modes	A-TTL program automatic flash, TTL program automatic flash, Manual		
Flash Metering System	TTL automatic flash metering of light reflected off the film plane.		
Flash Exposure Compensation	<ol style="list-style-type: none"> <li>(1) Automatic flash output reduction control provided in daylight fill-in flash situations;</li> <li>(2) Manual compensation can be set on the flash within a range of <math>\pm 3</math> stops in 1/3-stop increments. (Possible in all shooting modes except fully-automatic shooting modes.)</li> <li>(3) With some EOS models, flash exposure compensation is possible from the camera side by turning the main dial.</li> </ol>		
Flash Coupling Range (50mm f/1.4, ISO 100)	A-TTL normal firing: 0.5~30m / 1.7 ~ 99ft, Quick firing: 0.5~7.5m / 1.7 ~ 25ft (min.) to 0.5~21m / 1.7 ~ 69.3ft (max.).		
X-sync Shutter Speed	(See page 31)		
Flash Charge Completion Indicators	When the ready lamp lights red, normal firing is possible; When the ready lamp lights green, quick firing is possible.		

AF Auxiliary Light & Effective Distance Range	Corresponds to 5 focusing points. Center: approx. 0.5 ~ 15m / 1.7 ~ 49.5ft (in dark situations); Left/Right: approx. 0.7 ~ 6m / 2.3 ~ 19.8ft (in dark situations).
Power Supplies	Built-in power supply: (1) Four AA-size alkaline-manganese batteries (LR6/AM-3) (2) Four AA-size Ni-Cd batteries (KR15/51) (3) Four AA-size lithium batteries (FR6)  External power supplies: (1) Six AA-size alkaline-manganese batteries (LR6/AM-3) (2) Battery Magazine TP (holds six C-size alkaline-manganese batteries [LR14/AM-2]) (3) Ni-Cd Pack TP
Save Energy Function	When the main switch is set to the SE position, the power automatically turns off after 90 seconds of inactivity.
Mode Memory	The 540EZ automatically memorizes its status information including the control mode and zoom position when the power is turned off.
Dimensions	80 (W) × 138 (H) × 112 (D) mm / 3-1/8" (W) × 5-7/16" (H) × 4-7/16" (D)
Weight	405g / 14.2oz (main unit only)

### Guide Numbers: (ISO 100 · m)

Coverage angle (mm)	18	24	28	35	50	70	80	105	
Normal (full power) firing (G-No)	16	28	30	36	42	46	50	54	
Quick firing	Same as manual firing at 1/2~1/16 output levels								
Manual firing (guide number)	1/1	16	28	30	36	42	46	50	54
	1/2	11.3	19.8	21.2	25.5	29.7	32.5	35.4	38.2
	1/4	8	14	15	18	21	23	25	27
	1/8	5.7	9.9	10.6	12.7	14.8	16.3	17.7	19.1
	1/16	4	7	7.5	9	10.5	11.5	12.5	13.5
	1/32	2.8	4.9	5.3	6.4	7.4	8.1	8.8	9.5
	1/64	2	3.5	3.8	4.5	5.3	5.8	6.3	6.8
	1/128	1.4	2.5	2.7	3.2	3.7	4.1	4.4	4.8

- \* The 18mm coverage angle figures are for when the built-in wide panel is used.
- \* For guide numbers based on feet instead of meters, perform the following calculation: Guide No. (ft) = Guide No. (m) × 3.3

### Battery Life (No. of Bursts) and Recycle Time

Power Supply		Battery life (No. of bursts) (approx.)	Recycle time (sec.)	
			Quick firing (approx.)	Normal firing (approx.)
Built-in power supplies	4 AA-size alkaline	120~ 800	0.2~ 2	0.2~ 12
	4 AA-size Ni-Cd	50~ 350	0.2~ 1.5	0.2~ 6
External power supplies	Transistor Pack E with Ni-Cd Pack TP	350~2000	0.2~ 1	0.2~ 3
	Transistor Pack E (4 alkaline C-cells)	400~2500	0.2~ 1.5	0.2~ 5
	Compact Battery Pack E (LR6/AM-3)	400~2500	0.2~ 1.5	0.2~ 5

- \* In the battery life column, figures on the right indicate the number of bursts in A-TTL mode, and figures on the left indicate the number of bursts in manual (1/1) mode.  
The number of bursts possible at the 1/2, 1/4, 1/8, 1/16, 1/32, 1/64 and 1/128 manual power settings, are greater than number of bursts possible at the full-power (1/1) setting by factors of 2, 4, 8, 10, 12, 15 and 18, respectively.
- \* In the recycle time column, the left-hand values are the flash recycle times in A-TTL mode, and the right-hand values are the flash recycle times in manual mode at full (1/1) power.

# 540EZ Function Chart For EOS Cameras

※ Possible only in shutter-priority AE mode. The aperture is fixed at f/5.6 in bulb mode. □ : Full Auto mode

Model name	Fastest flash-synchronizing shutter speed				3-zone automatic flash metering	A-TTL auto flash	Camera-based flash exposure compensation	Stroboscopic flash	2nd-curtain sync	Full auto camera settings when using flash	Cameras with bulb exposure
	1/90	1/125	1/200	1/250							
EOS 650		●			×	●	×	●	●	□	●
EOS 620				●	×	●	×	●	●	□	●
EOS 750		●			×	●	×	×	×	PROGRAM	×
EOS 850		●			×	●	×	×	×	PROGRAM	×
EOS 630		●			×	●	×	●	●	□	●
EOS-1				●	×	●	×	●	●	P	●
EOS RT		●			×	●	×	●	●	P	●
EOS 10/ 10S		●			●	●	×	●	●	□	●
EOS 700		●			×	●	×	● ※	● ※	P	● ※
EOS 1000/ REBEL	●				×	●	×	●	●	□	●
EOS 100/ ELAN		●			×	●	×	●	●	□	●
EOS 1000N/ REBEL II	●				×	●	×	●	●	□	●
EOS 5/ A2/ A2E			●		●	●	●	●	●	□	●
EOS 500/ REBEL X	●				●	●	×	●	●	□	●
EOS 1 N/ 1 N RS				●	●	●	●	●	●	P	●

\* The EOS 5/ A2/ A2E, EOS 10/ 10S and EOS 500/ REBEL X have built-in AF auxiliary lights which override the 540EZ's AF auxiliary light.

## ● Exposure Warnings (on the EOS camera side)

Shooting mode	Warning indicator	Meaning	Remarks
Aperture-priority AE	The X-sync shutter speed blinks.	The background will be overexposed.	The main subject will be exposed correctly. Try changing the aperture until the shutter speed stops blinking.
Shutter-priority AE	The minimum aperture value of the lens blinks.	The background will be overexposed.	The main subject will be exposed correctly.
	The maximum aperture value of the lens blinks.	The background will be underexposed.	
Program AE	The minimum aperture value of the lens blinks.	The subject is too bright.	Attach a neutral density (ND) filter to reduce the amount of light entering the lens.



**CANON INC.** 30-2, Shimomaruko 3-chome, Ohta-ku, Tokyo 146, Japan

U.S.A.	<b>CANON U.S.A., INC.</b> FOR ALL INQUIRIES CONCERNING THIS CAMERA, CALL TOLL FREE IN THE U.S. 1-800-828-4040 OR WRITE TO: CUSTOMER RELATIONS, CANON U.S.A., INC. ONE CANON PLAZA, LAKE SUCCESS, NY 11042-1113
CANADA	<b>CANON CANADA INC. HEADQUARTERS</b> 6390 Dixie Road, Mississauga, Ontario L5T 1P7, Canada <b>CANON CANADA INC. MONTREAL SERVICE CENTRE</b> 10652 Côte de Liesse, Lachine Quebec H8T 1A5, Canada <b>CANON CANADA INC. CALGARY OFFICE</b> 2828, 16th Street, N.E. Calgary, Alberta T2E 7K7, Canada
EUROPE, AFRICA & MIDDLE EAST	<b>CANON EUROPA N.V.</b> Bovenkerkerweg 59-61, P.O. Box 2262, 1180 EG Amstelveen, The Netherlands <b>CANON PHOTO VIDEO FRANCE S.A.</b> "Le Doublon" 11, Avenue Dubonnet 92407 Courbevoie Cedex, France <b>CANON UK LTD.</b> Units 4 & 5, Brent Trasing Centre. North Circular Road, London NW10 0JF, United Kingdom <b>CANON EURO-PHOTO G.m.b.H</b> Siemensring 90-92, D-47877 Willich 1, Germany
CENTRAL & SOUTH AMERICA	<b>CANON LATIN AMERICA, INC. DEPTO. DE VENTAS</b> Apartado 7022, Panamá 5. República de Panamá <b>CANON LATIN AMERICA, INC. CENTRO DE SERVICIO Y REPARACION</b> Apartado 2019, Zona Libre de Colón, República de Panamá
SOUTHEAST ASIA	<b>CANON HONGKONG TRADING CO., LTD.</b> 10/F., Mirror Tower, 61 Mody Road, Tsimshatsui East, Kowloon, Hong Kong. <b>CANON SINGAPORE PTE. LTD.</b> 79 Anson Road #09-01/06 Singapore 0207
OCEANIA	<b>CANON AUSTRALIA PTY. LTD.</b> 1 Thomas Holt Drive, North Ryde, N.S.W. 2113, Australia <b>CANON NEW ZEALAND LTD.</b> Fred Thomas Drive, P.O. Box 33-336, Takapuna, Auckland, New Zealand
JAPAN	<b>CANON SALES CO., INC.</b> 12-15, Mita, 3-Chome, Minato-ku, Tokyo 108, Japan

This device complies with Part 15 of the FCC Rules. Operation is subject to the following two conditions: (1) This device may not cause harmful interference, and (2) this device must accept any interference received, including interference that may cause undesired operation.

Do not make any changes or modifications to the equipment unless otherwise specified in the instructions. If such changes or modifications should be made, you could be required to stop operation of the equipment.

This equipment has been tested and found to comply with the limits for a class B digital device, pursuant to part 15 of the FCC Rules. These limits are designed to provide reasonable protection against harmful interference in a residential installation. This equipment generates, uses and can radiate radio frequency energy and, if not installed and used in accordance with the instructions, may cause harmful interference to radio communications.

However, there is no guarantee that interference will not occur in a particular installation. If this equipment does cause harmful interference to radio or television reception, which can be determined by turning the equipment off and on, the user is encouraged to try to correct the interference by one or more of the following measures:

- Reorient or relocate the receiving antenna.
- Increase the separation between the equipment and receiver.
- Consult the dealer or an experienced radio/TV technician for help.

This digital apparatus does not exceed the Class B limits for radio noise emissions from digital apparatus as set out in the interference-causing equipment standard entitled "Digital Apparatus", ICES-003 of the Industry Canada.



The CE Mark is a Directive conformity mark of the European Community (EC)









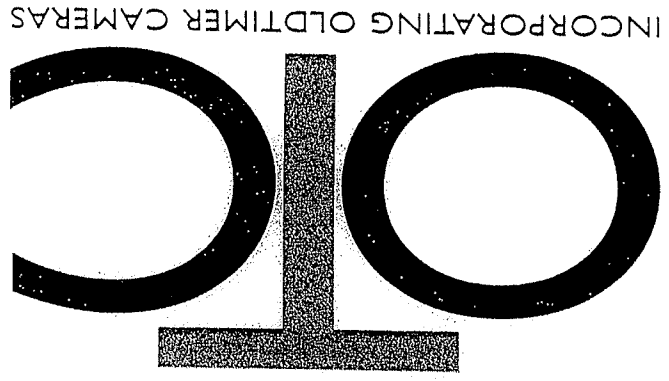

OTC Ltd, 24 Market Place, Hatfield, Herts, AL10 0LN  
Tel: 01707 273773 Fax: 01707 273774 Email: sales@otcworld.co.uk www.otcworld.co.uk